

# BOROSIL<sup>®</sup>

Manufacturers of Laboratory Glassware  
From 3.3 Low Expansion Borosilicate Glass



## Catalogue

*Over half a century of trust*

## MISSION & VISION

Our mission is to emerge as a preferred vendor for laboratory glassware in the domestic as well as international markets. We would also develop a complimentary range of laboratory consumables in our product portfolio.

While in this wonderful journey we want to enhance our marketing capabilities, continuously improve our quality and services, invest in our people, yield profits for our stake holders and be socially responsible.



## Message from the Managing Director's Desk

Dear Customer!

Greetings for the financial year 2017-18!

The new edition of our product catalogue has been further optimized in order to facilitate your daily work when selecting the right consumables for your needs. Though we have maintained the structure of previous editions, we would like to draw your attention to the indexing, product grouping & photographic illustration in this edition. All of this is done in order to ensure simplicity in your decision making process.

Borosilicate glass from which laboratory ware is made, is truly a wonder material. We've tried to communicate some of the intricate details of this material using contemporary caricature.

The brand BOROSIL is not limited to excellence in product quality & service delivery. Above all, it symbolizes 'TRUST'. This 'TRUST' radiates from our core value of 'Customer Centricity'. It's a promise that BOROSIL will always keep our customer's interests paramount in everything that we do. In line with this theme, we are rolling out the new **BOROSIL**<sup>®</sup> logo as the common brand across all our offerings.

We've always worked in close connect with our customers. In fact, most products in our portfolio have evolved after inputs from the actual users of our products. This year, under **LABQUEST** we are delighted to introduce new exciting products such as,

In Equipments,

- o Multi vortexer
- o Disc rotators
- o Tube rotators
- o High throughput centrifuge
- o High volume magnetic stirrers

In Liquid Handling Systems

- o The new C1 micropipette range for research applications
- o C3 - the new eco micropipette range for basic applications
- o Fastpipette, a new pipette controller

In Analytical Vials

- o A full range of storage & sampling vials has been added

We hope that the improved catalog will be a useful guide in finding the right product that meets your needs.

Wishing you the very best.

Yours truly,

**Shreevar Kheruka**

**BOROSIL**<sup>®</sup>

an ISO 9001: 2008 certified company

**Corporate Office :**

1101, Crescenzo, G - Block, Opp. MCA Club, Bandra Kurla Complex,  
Bandra (E), Mumbai - 400 051, India.

Phone : +91-22-6740 6300 Website : [www.borosil.com](http://www.borosil.com)

# **BOROSIL<sup>®</sup>**

## **Quality Policy**

"We, at Borosil Glass Works Limited, are committed to understanding our customers' needs and fulfilling the same on time every time.

By bringing the voice of our customers inside the organization, we strive to be our customers' #1 preferred brand.

We are committed to achieving the highest level of customer satisfaction through improvements in quality of our products & services.

This will be achieved by our total commitment :

- Communication with our customers to understand their needs.
- Continuously updating of our technical competence, systems and processes.
- Enhancing the expertise of our people by periodic training & reviews."

Date : 01.04.2015



**Shreevar Kheruka**  
Managing Director

# welcome to **BOROSIL®**

***State of the art  
manufacturing facility at Bharuch***



## ***Corporate Profile***

The BOROSIL Group comprises of

- Borosil Glass Works Limited
- Gujarat Borosil Limited
- Hopewell Tableware Private Limited
- Klasspack Private Limited

**Borosil Glass Works Ltd. (BGWL)** was established in December 1962 in collaboration with Corning Glass Works, USA, to manufacture borosilicate low expansion glass. In December 1988, Corning divested its shareholding to the current Indian promoters, who have been leading manufacturers of sheet glass in India, since 1961.

BOROSIL is the market leader in laboratory glassware and microwavable kitchenware in India.

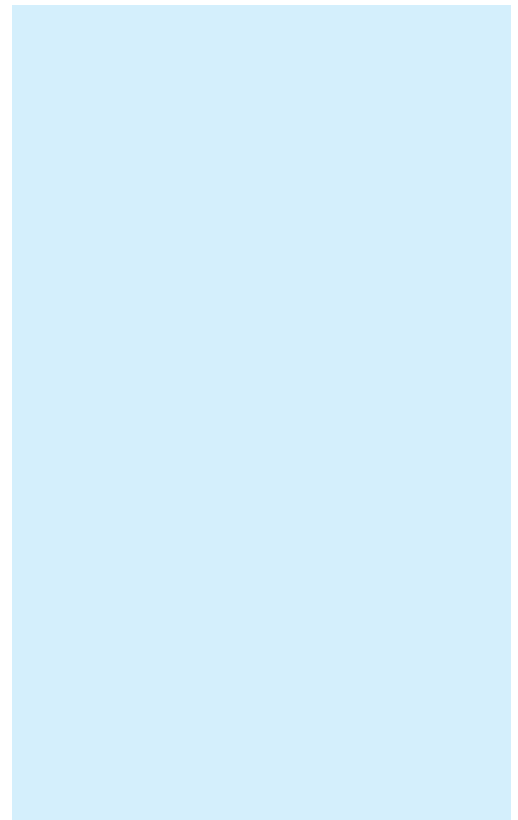



## Scientific and Industrial Products (SIP) Division

Borosil's SIP division offers an entire gamut of the finest quality scientific and laboratory equipment through a pan India network of 150 dealers. This includes laboratory glassware, instruments, disposable plastics, liquid handling systems and explosion-proof lighting glassware. This range of over 2000 products finds application in across diverse disciplines such as Quality Control in pharmaceutical industries, food and soil testing, Microbiology, Biotechnology, Photo Printing, Process Systems and Lighting. Symbolising quality, accuracy and dependability since 53 years, Borosil has earned the trust and unwavering loyalty of leading pharmaceutical companies and R&D laboratories, as well as scientific, health and educational institutions.



## Consumer Products Division

Borosil's consumer products division offers microwavable and flameproof kitchenware and iconic Vision glass tumblers through over 10,000 retail outlets, establishing Borosil Glass Works Ltd. (BGWL) as India's market leader in microwavable and flameproof kitchenware. Owing to the elegance, dependability, safety and ease of use of these products, Borosil has become synonymous with microwavable glassware in Indian homes. It continues to maintain its stronghold as one of India's best known and most trusted brands for over 5 decades. Borosil International's range of stylish heat resistant glassware is loved and preferred by homemakers.

Providing complete solutions, Borosil's Consumer products fulfil all cooking, serving and dining needs. Research studies reveal that customers associate Borosil with several positive attributes including quality, style and performance. To cater to changing lifestyle needs and aspirations, we have introduced a range of smart, practical and elegant Small Appliances, backed with Borosil's guarantee. These include Mixer Grinders, Induction cooktops, Oven Toaster Grillers, Toasters and Rice Cookers.

**Borosil Glass Works has recently acquired Hopewell Tableware Pvt Ltd.** Hopewell produces a range of fine Opal glass dinnerware under the brand 'Larah'. Larah products are a beautiful blend of elegance and performance, and are synonymous with Borosil's quest for perfection and excellence for over 50 years. Borosil has lent its expertise in glassware to this category making the products stronger and chip resistant. Contemporary designs, a plethora of sizes and colors coupled with the durability and toughness of the Opal glass result in this immaculately designed product with impeccable finish, to give the perfect dining experience.



## Gujarat Borosil Ltd.

Over 50 years of expertise in producing specialty glass including rolled glass makes Gujarat Borosil Limited an invaluable member of the Borosil group. Its state-of-the-art facility with production capability of 180 MT/day manufactures low iron high-transmission textured solar Glass for solar photovoltaic, solar thermal applications, and extra clear patterned glass for diverse architectural applications. GBL is the only manufacturer of solar glass in India. The entire production line has been imported from world leaders of glass equipment in West Europe, making GBL's solar Glass the most technically advanced in the world. Long term performance durability, high hydrolytic resistance and outstanding performance durability of its anti-reflective coating make this glass truly superior. Moreover, GBL's solar Glass has the lowest iron in the world and has been certified with glass efficiency value of 0,952 from SPF Switzerland, ranking higher than other glasses tested. Pioneering the world, we are the only company to create solar Glass without adding highly toxic substance antimony in the glass composition. Engineered primarily for the sun, GBL's solar Glass delivers maximum power output in the field.

*Larah*  
— OPALGLASS —  
by **BOROSIL**®



# **BOROSIL** **KLASSPACK**

pharmaceutical packaging







Klasspack Pvt. Ltd., now a subsidiary of Borosil Glassworks Ltd., is one of India's leading manufacturers of Glass Ampoules and Tubular Glass Vials of USP Type 1 that is widely used as primary packaging materials by pharmaceutical companies for their life-saving drugs. The factory is located at Nasik, around 180 kms from Mumbai.

Klasspack Pvt. Ltd. was established in 1994 and quickly became a leader in the Pharmaceutical Packaging segment. Borosil acquired Klasspack in 2016 and combined its technological expertise in specialty glass production with Klasspack's experience in worldclass glass ampoule and tubular glass vial manufacturing to establish its leadership in the fast-growing Pharmaceutical Packaging segment.

Klasspack has registered products under the US DMF governed by US FDA for both Glass Ampoules and Tubular Glass Vials, and Canadian DMF (Neutral Glass Tubular Vials and Neutral Glass Ampoules). It has a state-of-the-art technology with installed capacity of over 450 million Glass Ampoules and over 165 million Glass Vials annually.

Klasspack is focused on a knowledge-based approach towards product development, and has pioneered various studies in India on its glass containers such as extraction studies. A dedicated team handles product development and regulatory documentation, and can render technical support in glass ranging from laboratory-scale to commercial production scale.

Klasspack is staffed with one of the most dynamic and qualified teams in the industry. It has won over customers with its flexible approach towards product customization and packaging, and a customer centric approach. It has built a solid reputation for quality and transparency, and meeting delivery commitments consistently without fail.

With a presence in more than 50 countries that includes the U.S., Netherlands, Italy, U.K., Israel, Romania, Malaysia and Indonesia, Klasspack intends to further enhance its market-leading position in India and across the world, and offer pharma majors a reliable partner to source their primary glass packaging.

### **Klasspack Pvt. Ltd.**

(A Subsidiary of Borosil Glass Works Limited)  
info.klasspack@borosil.com  
www.klasspack.com

### **Registered Office**

H-27, MIDC, Ambad, Nashik 422010, India  
T: +91 253 2382 404 / F : + 91 253 2387 907

### **Mumbai Office :**

Borosil Glass Works Ltd.  
1101, Crescenzo, G-Block, Opp. MCA Club,  
BKC, Bandra (E), Mumbai - 400 051, India  
T : +91 22 6740 6300 / F : +91 22 6740 6514

## **foreword**

Borosil Glass Works Ltd. presents to you, this Borosil Scientific and Industrial product catalogue.

## **special or non-standard glassware**

We undertake the manufacture of special glassware to agreed specifications. Please send us your queries at the address below, including complete details of specifications, and drawings wherever possible. We would be pleased to assist you in formulating specifications within normal working tolerances. Usually, we only accept orders with a minimum order quantity.

### **Corporate Office :**

#### **Borosil Glass Works Ltd.**

Crescenzo, G-Block, Opp. MCA Club,

Bandra Kurla Complex,

Bandra (E), Mumbai - 400 051, India

Tel : 022 - 6740 6300

Fax : 022 - 6740 6514

Email : lab.customercare@borosil.com

## **conditions of sale**

At Borosil, it is our policy to market our laboratory glassware through our wide network of Authorised Dealers. Strategically located all over World, they are best equipped to satisfy the individual requirements of users across the World. The products supplied will usually be in accordance with illustrations and descriptions however, Borosil reserves the right to make alterations and modifications depending upon circumstances and/or changes in official specifications, or as a result of design improvements.

Although the products are guaranteed for glass quality and workmanship, Borosil shall not be liable for any loss or damage or injury, arising directly or indirectly from the use of these products.

The images given in the Catalogue are for reference purpose only.  
Actual products may differ from the images.

## factory and production

### automatic blank manufacturing facility



- State-of-art auto blowing facility used to produce blanks with uniform wall thickness and ensure exact shape and dimension according to the standards.
- All the blanks are manufactured from 3.3 Low Expansion Borosilicate Glass with controlled Internal Diameter tubing.

### unique annealing facility



- All **Borosil** glasswares pass through annealing Lehr chamber where the stresses are eliminated under controlled heating and cooling process
- This annealing process ensures the long lasting printing quality. In order to get highest level of precision, carefully controlled gradual heating and cooling procedures are essential

### petri dish manufacturing facility



***manufacturing facility at Tarapur***



***advanced printing technology***



***wall thickness measure***



- High definition printing for accurate and easy reading

***automated vial forming machine***



## our warehouses

Six warehouses with floor area more than 1,50,000 Sq. feet PAN india



17,000 sq feet warehouse  
at MM Nagar, Chennai

## calibration process



**BOROSIL** is India's single largest manufacturer of a complete range of Volumetric Glassware. Borosil's Volumetric products are used in all laboratories from high-end pharmaceutical production companies to high schools and colleges.

**BOROSIL** adheres to the highest quality standards, right from the raw material used to the measurement and calibration of the finished product. Visual and physical quality checks are undertaken at each stage of production, in order to ensure the highest quality product for customers.

**BOROSIL** ensures that every Volumetric Glassware product is of the highest quality in the following parameters:

1. **Accuracy** : Please see 'Calibration Process' for a detailed understanding of how Borosil Volumetric Glassware is the most accurate in the world.
2. **Mechanical Strength** : All Borosil laboratory glassware products are annealed in a special chamber wherein the stress as developed during the manufacturing process is eliminated with a controlled heating and cooling process. Moreover, Borosil's production processes ensure uniform wall thickness across all products, thereby enhancing their mechanical strength.
3. **Thermal Shock Resistance** : The annealing process further ensures that Borosil products are free of residual stress. The uniform wall thickness of Borosil products prevents damage owing to repeated heating and cooling in laboratories.
4. **Chemical Durability** : All Borosil laboratory glassware products are manufactured using 3.3 low expansion ASTM E-438 Type 1 Class A borosilicate glass. This glassware, by nature, is resistant to attack from acids, salt solutions and organic solvents.

## calibration process



Computer controlled automatic calibration machine with optical laser beams to prevent human error and ensure highest level of accuracy and precision

**BOROSIL** performs the calibration process with fully automatic state-of-the-art calibration machines that eliminate any possibility of human error. This also ensures a high degree of repeatable measurements for all Borosil Volumetric products.

**BOROSIL** has an in-house set-up of a well-equipped temperature-controlled calibration laboratory with precision electronic balances, thermometers and stopwatches that are traceable to national standards. Calibration of Volumetric Glassware is entrusted to only trained and experienced technicians.

The following steps are carried out by highly precise, fully automated computer-controlled machines:

1. Filling the Volumetric blanks with a precisely-defined amount of de-mineralized water under controlled temperature.
2. The meniscus is determined with a laser-controlled camera at the exact lowest point of the water level, and the calibration mark is made with a fine diamond wheel. This gives accuracies that cannot be achieved by manual calibration.
3. Cylinders, Burettes and Pipettes are marked at a minimum of two calibration points.
4. The wet surface area factor is always taken into account, throughout the process.
5. The calibration laboratory is temperature, light controlled and temperature is maintained at  $23^{\circ}\text{C} \pm 2^{\circ}\text{C}$ .

All Volumetric Glassware is calibrated either as **To contain TC / In**

The contained quantity of liquid corresponds exactly to the capacity indicated on the article (e.g. graduated cylinders and volumetric flasks).

**To deliver TD / Ex**

The delivered quantity of liquid corresponds exactly to the capacity indicated on the article. (e.g. pipette and burettes).

These steps ensure that each and every Volumetric product leaving the **BOROSIL** facility meets the highest international standards and can be used for various purposes with the highest degree of repeatability and accuracy.





## NABL certified products

In this catalogue, we present the complete range of Borosil products that are available with a Calibration Certificate issued by the NABL-accredited laboratory.

In certain critical areas, it is mandatory that representative samples of Volumetric products used by the laboratories be sent to NABL-accredited laboratories for testing of the calibration.

With the establishment of our own facility, our customers can now get the products certified by our laboratory directly, without sending them to other laboratories, saving a considerable amount of time and cost.





## ISO certification



- Developed with today's complex marketplace in mind, ISO 9001:2008 provides an integrated approach to quality management – putting quality at the heart of business.
- ISO 9001 is a quality management system, implementing a systematic and process driven approach to managing our business.
- A Quality Management System is what ensures a business' products or services meets a certain level of quality; that is, they are reliable, safe, consistent, meet customer expectations, continuously improve and comply with the law.

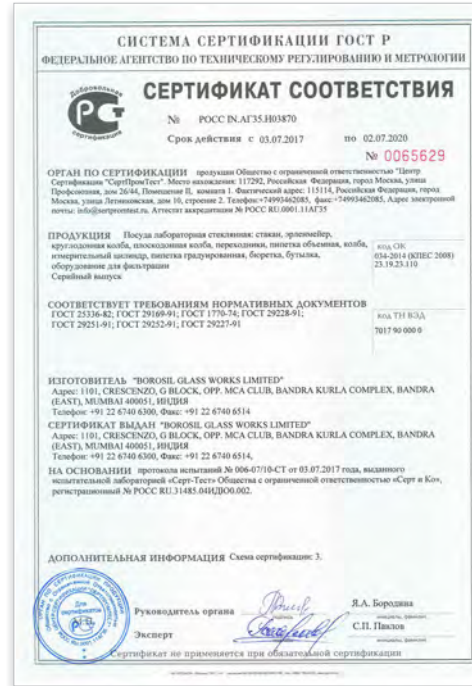

## Individual calibration certificate

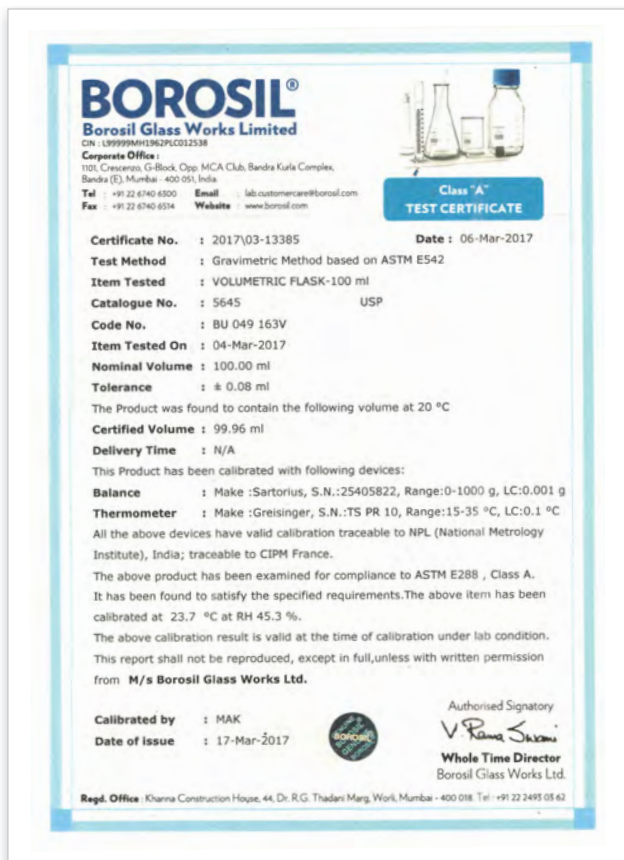

Now ACCESS your BOROSIL glassware certification from anywhere, anytime.....



Download the **BOROSIL®** app 

Individual Calibration Certificate can also be accessed on [www.borosil.com](http://www.borosil.com)



Rain water harvesting has been deployed in our 110 acre facility in Gujarat, since 2003.

Wind energy is the source of 48% of all the electricity that we consume.

Our Borosolar water heating systems are used to heat the water supplied in all Borosil Guesthouses and Colonies.

Our other energy efficient measures include advanced waste heat recovery systems and solar lighting.

Our in-house 9 hole par 36 Golf Course is maintained by using the water from our rain water harvesting initiative.

### ***We nurture***

Borosil supports and runs a school, for children from neighbouring villages and employees' children.

Borosil proposes to open a hospital in the near future.





Did  
You  
Know?

**BOROSIL®**

**Borosil**

For more than half a century,  
Borosil has engaged with its customers through products  
that have earned their trust.

We strive to adhere to our core values of  
Integrity, Customer focus, Respect, Continual Improvement, Accountability & Safety.  
To reflect and remain continually focussed to this commitment, this year,  
we're bringing all our offerings under one corporate brand

**BOROSIL®**



In the transition from **BOROSIL®**  to **BOROSIL®** articles may carry one of the three logos

## Technical Information

### Borosil Low Expansion Borosilicate Glass:

From the 16th century to the present day, chemical research teams have been using glass containers for a very simple reason... As the glass container is transparent, the contents and the reaction are clearly visible. However, since chemists need to heat, cool and mix chemical substances, ordinary glass is not always appropriate for laboratory work.

Laboratory work requires apparatus made of glass that can readily be moulded into any desired shape or form. It requires glass that offers maximum inertness when in contact with the widest range of chemical substances. The glass should have the capability to withstand thermal shock without fracture, and it should facilitate high temperature work without deforming. It should be resilient enough to survive the everyday knocks to which it will be subjected in normal laboratory handling, washing and sterilising processes.

**Borosil** is the trade name of such a glass.

The products represent optimum mechanical, thermal and chemical behaviour. This glass is used in laboratories as well as for industrial applications, where thermal shock resistance, mechanical resistance as well as unusual chemical resistance are required.

Borosil glass is a low alkali borosilicate Type 3.3 glass. Its typical chemical composition is given below. It is virtually free from the Magnesia-Lime-Zinc group, and is also completely free of arsenic and other heavy metals.

	Approx % by weight
SiO <sub>2</sub>	81
B <sub>2</sub> O <sub>3</sub>	13
Na <sub>2</sub> O / K <sub>2</sub> O	4
Al <sub>2</sub> O <sub>3</sub>	2

### Thermal Properties

Borosil glass has a low co-efficient of thermal expansion. Consequently, the thermal stresses under a given temperature gradient are also low. The glass can withstand higher temperature gradients and also sudden temperature changes / thermal shocks. Minute scratching of the glass surface can, however, reduce its thermal resistance.

'Strain Point' should be regarded as the maximum safe operating temperature for Borosil glassware. When heated above 500°C, the glass may acquire permanent stresses on cooling.

All Borosil laboratoryware is annealed in a modern Lehr, under strictly controlled conditions to ensure minimal residual stresses in the products.



The typical thermal properties of Borosil glassware are mentioned below :

<b>Coefficient of Linear Expansion</b>	<b>32.5 x10<sup>-7</sup> cm / cm / °C</b>
<b>Strain Point</b>	<b>515°C</b>
<b>Annealing Point</b>	<b>565°C</b>
<b>Softening Point</b>	<b>820°C</b>
<b>Specific Heat</b>	<b>0.2</b>
<b>Thermal Conductivity (Cal / cm<sup>3</sup> / °C / sec)</b>	<b>0.0027</b>

### Chemical Data

BOROSIL 3.3 Glass is highly resistant to water, neutral and acid solutions, concentrated acids and acid mixtures, and to chlorine, bromine, iodine and organic substances. The chemical resistance of this glass is superior to that of most metals and other materials, even when exposed to long processing periods and temperatures above 100 °C. A slight release of mainly monovalent ions takes place after exposure of the glass to water or acids. A very thin layer of impervious silica gel is subsequently formed on the surface of the glass, which in turn slows down further attack. At higher temperatures and in more concentrated forms the glass surface is subject to increased attack by hydrofluoric acid, hot phosphoric acid and alkaline solutions.

<b>Hydrolytic Class (ISO 719)</b>	<b>HGB 1</b>
<b>Acid Class (DIN 12 116)</b>	<b>S 1</b>
<b>Alkali Class (ISO 695)</b>	<b>A 2</b>

### Safe Use of Glassware

Borosil laboratory apparatus is designed to perform efficiently and last long, provided it is used with proper care. The following notes are presented to assist users in deriving the maximum life and performance from their Borosil apparatus.

The following precautions will assist in preventing failures during heating and cooling procedures.

- Do not leave the vessel unattended when evaporation work is being carried out. The vessel may crack or explode as the 'dryness' condition approaches and if the heat source is not adjusted correctly. Decrease the temperature gradually as the liquid level drops.
- Always stay cautious when removing glassware from a heat source. Avoid placing it on a cold or damp surface.
- Even though glassware can withstand extreme temperatures, please keep in mind that sudden temperature changes may cause the vessel to break.
- Always cool vessels slowly to prevent thermal breakage.
- Never apply heat to badly scratched or etched vessels as their thermal strength would have been greatly reduced.
- Never apply point source heating to a vessel; it increases the possibility of breakage.



- Always diffuse the heat source by using a metal gauze or air/water bath. Alternatively, move the vessel slowly in relation to the heat source to ensure even heating.
- Adjust the Bunsen Burner to get a large, soft flame. It will heat slowly, but uniformly. Uniform heat is a critical factor for some chemical reactions.
- Ensure that the flame is in contact with the vessel below the liquid level. Heating above this level may result in breakage of the vessels.
- Always use anti-bumping devices in the vessel, such as powdered pumice or glass wool, when the vessel and its contents are required to be heated rapidly.
- Never use any material with sharp edges, such as broken porcelain, as an anti-bumping device. This will cause internal abrasions and reduce the mechanical and thermal strength of the vessel.
- Thick-walled glassware should not be subjected to direct flame or any other localised heat source. An electric immersion heater is ideally used for heating vessels of this type.
- Thick-walled glassware should not be subjected to direct flame or any other localised heat source. An electric immersion heater is ideally used for heating vessels of this type.
- Avoid heating glassware over electric heaters with open elements. Uneven heat of this type can induce localised stress and increase the possibility of breakage.
- Always keep in mind that a hot plate will retain heat long after the appliance has been switched off.
- Always ensure that the surface of the hot plate is larger in area than the base of the vessel being heated. A plate that is under-sized for the job at hand will result in uneven heating and may even cause breakage of the glassware.
- Always ensure that manufacturer's instructions are followed when using electrical heat sources.

### Mixing and Stirring

- Always use a teflon sleeve or a similar device on stirring rods, to prevent scratching of the inside of the vessel.
- When using a glass vessel with a magnetic stirrer, always use a covered follower. This prevents abrasion of the inside of the vessel.
- When using a glass or metal mechanical stirrer in a glass vessel, always pre-determine the height of the stirrer before use, to ensure that the stirrer blade does not come in contact with the base or sides of the vessel.
- Never mix sulphuric acid and water inside a glass measuring cylinder. The heat caused by the reaction can break the base of the cylinder.

### Vacuum and Pressure

- Never use glassware beyond the recommended safe limit.
- Always use a safety screen when working with glassware subjected to pressure or vacuum.
- Never subject glassware to sudden pressure changes
- Apply and release positive or negative pressures gradually.

### Joining and Separating Glass Apparatus

- When storing glass stopcocks and joints, insert a thin strip of paper between the joint surfaces to prevent them from sticking.
- Do not store stopcocks with lubricants on the ground surfaces for long durations.
- Glass stopcocks on Burettes and Separating Funnels require frequent lubrication to prevent them from sticking.
- If a ground joint sticks, separation can usually be achieved by carefully rocking the Cone in the socket, or gentle tapping the socket flange on a wooden surface, or by heating the socket and not the Cone in a localised flame. Using penetrating oil facilitates separation.
- When using lubricants, it is advisable to apply a light coat of grease all around the upper part of the joint. Use only a small amount, and avoid greasing the part of the joint that comes in contact with the inside of the apparatus.
- Three types of lubricants are commonly used on standard taper joints.
  - (a) Hydrocarbon grease is the most widely used. It can be removed easily by most laboratory solvents, including acetone.
  - (b) As hydrocarbon grease is easy to remove, silicon grease is usually preferred for higher temperature or high vacuum applications. It can be removed with chloroform easily.
  - (c) For long-term reflux or extraction reactions, a water-soluble, organic and insoluble grease such as glycerin, is suitable. Glycerin can be removed by means of water.
- When inserting glass tubing into a bung, it is recommended to use water, oil or glycerol on both, the tubing as well as the rubber bung. Always wear heavy protective gloves or similar protection when carrying out this operation.
- Always fire-polish the rough ends of the glass tubing before attempting to insert it into flexible tubing. The lubricants recommended above may also prove useful.
- Never attempt to pull a thermometer out of a rubber bung; always cut the bung away.

### Personal Safety

- Use tongs or asbestos gloves to remove any glassware from heat. Hot glass can cause severe burns.
- Protective gloves, safety shoes, aprons and goggles should be worn to safeguard against chemical accidents, spilling or splattering.
- Always flush the outside of the acid bottle with water before opening it. Do not place the stopper on the counter top, where someone else may come in contact with acid residue.
- Care should be taken when handling mercury. Even a miniscule amount of mercury in the base of a drawer can poison the atmosphere in an entire room. Mercury toxicity



is cumulative and the element's ability to amalgamate with a number of metals is well known. Following any accident involving mercury, the area should be checked thoroughly to ensure that there are no globules remaining. All mercury containers should be kept well stoppered.

- Never drink from a beaker. A beaker intended specifically for the use of drinking is a hazard in the laboratory. Do not taste chemicals to identify them. Smell chemicals only when necessary, and only by wafting a small amount of vapour towards the nose.
- Avoid using a Pipette with the mouth, particularly when using concentrated acids, alkalis or potentially bio-hazardous materials. Use mechanical means, such as a rubber bulb or an automatic dispenser.
- Do not fill the receptacle with any material other than that mentioned on the label. Label all containers before filling. Discard the contents of any unlabelled containers.
- To prevent breakage when clamping glassware, do not permit glass-to-metal contact, and do not use excessive force to tighten the clamps.
- Do not look down into a Test Tube being heated or containing chemicals, and do not point its open end at another person. A reaction could cause the contents to be ejected suddenly, resulting in injury.
- Splattering from acids, caustic materials and strong oxidising solutions on the skin or clothing should be washed off immediately with large quantities of water.
- When working with chlorine, hydrogen sulphide, carbon monoxide, hydrogen cyanide and other highly toxic substances, always use a protective mask. Alternatively, perform these experiments under a fume hood in a well ventilated area.
- In working with volatile materials, please keep in mind that heat causes expansion and confinement of such expansion results in explosion. Also remember that this danger exists even if external heat is not applied.
- Perchloric acid is particularly dangerous as it explodes when brought in contact with organic materials. Do not use perchloric acid around wooden benches or tables.
- Keep perchloric acid bottles on glass or ceramic trays with capacity that is adequate to hold all the acid in case the bottle breaks.
- When using perchloric acid, always wear protective clothing.
- When using hot plates and other electrical equipment, always ensure that the wire and plugs are in good condition. Do not handle an electrical connection with damp hands.

### Cleaning :

**Cleaning of new glassware:** New glassware is slightly alkaline in reaction. New glassware should be soaked for about 2 to 3 hours in acidic water ( 1 % solution of hydrochloric acid or nitric acid ). Rinse with water and then soak the empty glassware in a basin / tub containing 0.1 % solution of **Vetroclean** ( Borosil product code 9001033) or any suitable detergent solution for 20 to 30 minutes.

Follow the procedure of cleaning as given below.

- **Cleaning of regular glassware :** Remove the content of glassware before washing. Remove all markings / sticker labels from the glassware. Glassware should be brought to ambient temperature before subjecting them for cleaning, if they are heated or cooled during analysis. Rinse with water and then soak the empty glassware in a basin / tub containing 0.1% **Vetroclean** (Borosil product code 9001033) or any suitable detergent solution for about half an hour. Scrub all the parts of glassware thoroughly with brush impregnated with 0.1% **Vetroclean** or any suitable detergent solution. Brush should be selected as per the shape and size of the glassware. Brushes should always be in good condition to avoid any abrasion of the glassware. Do not use brushes with metallic bristles vigorously as it may form scratches on the surface. After applying cleaning agents thoroughly rinse glassware with tap water ensuring that containers are partly filled with water, shaken horizontally and vertically and emptied several times for effective cleaning. It is very important that all soap detergents and other cleaning fluids be removed from glassware before use. Finally rinse the glassware with purified water. Dry glassware in a drying oven at temperature at 60°C and store in a designated place.
- Glassware used for sticky, waxy or greasy material should be rinsed initially with acetone or hot water with detergent in which the material residue dissolves and then to be cleaned as per cleaning procedure.
- Glassware used for water immiscible solvents should be initially rinsed with acetone or suitable solvent.
- To remove precipitate materials or unduly clouded or coagulated organic matter from glassware apply hot nitric acid for effective cleaning.
- Strong alkali should not be used for cleaning of glassware. Also use of Chromic acid, sulphuric acid mixture is not recommended because of hazardous and toxic nature of the material.
- If glassware is exceptionally dirty, a cleaning powder with a mild abrasive action can be applied provided the surface is not scratched.
- Glassware required for total organic carbon (TOC) analysis should be scrupulously cleaned of organic residue. This can be achieved by rinsing glassware with hot nitric acid, followed by rinsing with purified water. Preferably such glassware should be maintained separately (away from organic solvents and materials) and to be dedicated for TOC determination analysis only.
- If the glassware is used for analysis of potent material such as steroids, hormones or cytotoxic, soak the glassware in suitable deactivating agent. After deactivation, clean as per cleaning procedure



### Pipettes cleaning :

- ◆ Place Pipettes with their tips down, in a cylinder or tall jar of water, immediately after use. Do not drop them into the jar as this may break or chip the tips and render the Pipettes useless for taking accurate measurements. A pad of cotton or glass wool at the base of the jar will help to prevent breaking of the tips. Please ensure that the water level is high enough to immerse the greater portion of all or each of the Pipettes. Then drain the Pipettes and transfer them into a cylinder or jar containing 0.1% **Vetroclean** solution or any suitable detergent solution. Allow it to soak in a jar or cylinder for about half an hour. Drain the pipette and run tap water over and through them until all contents are removed. Soak the Pipettes in purified water for at least one hour. Remove them and dry the external surface with a cloth, shake out the water and dry in oven.
- ◆ In laboratories where a large number of Pipettes are used everyday, it is convenient to use an automatic Pipette washer.
- ◆ After drying, place the Pipettes in a dust-free drawer. Wrap serological and bacteriological Pipettes in paper or place them in Pipette cans and sterilise them in the dry air steriliser at 160°C for two hours. A Pipette used for transferring infectious material should have a plug of cotton placed in its mouth end before sterilising.

### Burettes cleaning

- ◆ Remove stopcock key and wash the burette with 0.1% **Vetroclean** solution or any other suitable detergent solution
- ◆ Rinse with tap water until all the dirt is removed. Then rinse with purified water.
- ◆ Wash the stopcock key separately. Keep the cleaned burette in inverted position until dry. Open the stopcock and keep for drying. Before the stopcock key is replaced in the burette, lubricate the joint with a small amount of lubricant. Remember that burette stopcock keys are not interchangeable.
- ◆ Always cover tip of burettes with butter paper or aluminium foil, when not in use.
- ◆ Please note glass stopcocks are not interchangeable.
- ◆ The glass key and burette bore should be marked properly to avoid mixup.

### Culture Tubes

- ◆ Culture tubes which have been used previously must be sterilized before cleaning. The best general method for sterilising culture tubes is by autoclaving for 30 minutes at 121°C (15 lb pressure). Media which solidify on cooling should be poured out while the tubes are hot. After the tubes are emptied, brush with 0.1% **Vetroclean** solution or any other suitable detergent solution. Rinse thoroughly with tap water, rinse with purified water, shake out the water and dry in oven.
- ◆ If tubes are to be filled with a medium which is sterilized by autoclaving, do not plug until the medium is added. Both medium and tubes are thus sterilized with one autoclaving.
- ◆ If the tubes are to be filled with a sterile medium or if they are to be sterilized by the fractional method sterilize the tubes in the autoclaves or dry air sterilizer before adding the medium.

### Serological Tubes

- ◆ Serological Tubes should be chemically clean but need not be sterile. However, specimens of blood which are to be kept for some time at room temperature should be collected in a sterile container. It may be expedient to sterilize all tubes as routine.
- ◆ To clean and sterilize tubes containing blood, discard the clots in a waste container and place the tubes in a large basket. Put the basket with others, in a large bucket or boiler. Cover with water, add a fair quantity of soft soap or 0.1% **Vetroclean** solution or any other suitable detergent solution and boil for 30 minutes. Rinse the tubes and clean with brush, rinse and dry with the usual precautions.
- ◆ It is imperative when washing serological glassware that all acid, alkali and detergent be completely removed. Both acid and alkali in small amounts destroy complement and in larger amounts produce hemolysis. Detergents interfere with serologic reactions.
- ◆ Serological tubes and glassware should be kept separate from all other glassware and used for nothing except serologic procedures.



## Application Note

- Autoclaves are widely used to sterilise instruments, glassware and plasticware, solutions and media, and to decontaminate biological wastes. Due to the physical hazards (e.g. heat, steam and pressure) associated with autoclaving, extra care must be taken to use them safely. Each Autoclave has unique characteristics and operating requirements. Please review and understand the owner's manual before using any Autoclave for the first time, and every time thereafter. Also, please follow all the safety regulations for autoclaving, laid down by your institution.

## Autoclaving BOROSIL Glassware

- Borosil recommends the following safety practices when autoclaving laboratory glassware:
- Never autoclave items containing corrosives (e.g. acids, bases, phenol), solvents or volatiles (e.g. ethanol, methanol, chloroform) or radioactive materials.
- Place individual glassware vessels within a heat-resistant plastic or metal tray on a shelf or rack. Never place them directly on the Autoclave base or floor. Always maintain space (>5 cm) between glass vessels to give them room to expand while heating, and to prevent them from hitting other vessels when entering or leaving the Autoclave. Add water rising up to 1/4 to 1/2 inch in the tray, so that the glassware will heat more evenly.
- Check any plastic caps, tubing or other items to ensure they can be safely autoclaved with the glassware.
- Fill the glassware only half full with the liquids to be sterilised. Take into account, the volume of liquid to be autoclaved. A 2-litre flask containing 1 litre of liquid takes much longer to sterilise than four 500 ml flasks, each containing 250 ml of liquid.
- Do a test run when autoclaving larger volumes of liquid, to make sure that the liquid has reached 121°C.
- Large heavy glassware, such as 3L or larger spinner flasks, 5L or larger bottles and carboys should have a small amount of distilled water placed inside them to help generate steam when they are being sterilised dry in an Autoclave.
- Suspend an Autoclave thermometer with a thin wire, in the middle of the liquid-filled container to record the highest temperature reached. Then, check its reading after the Autoclave run is complete. If the temperature is too low, then the run-time will need to be increased or the volume will need to be reduced.

- To prevent bottles from getting shattered during pressurisation, the caps of the vessels with liquids must be loosened completely before loading. Always use the slow exhaust or liquid cool cycle when autoclaving liquids, to prevent the liquid from boiling over, causing loss of the contents.
- Never autoclave a sealed vessel containing liquids as this may result in an explosion of the super-heated liquid and steam during the cycle, or when the vessel is opened.
- Wear heat-resistant gloves when opening the Autoclave door after a cycle. When removing items from an Autoclave, at least a rubber apron, rubber sleeve protectors and heat-resistant gloves should be worn.
- Wait for 5 minutes before removing dry glassware from the Autoclave, and wait for 10 to 20 minutes before removing glassware containing liquids. The larger the volume of liquid, the longer you should wait. Liquids removed too soon may boil and overflow from the vessel, causing burns to the operator.
- Do not tighten caps on the vessels immediately after autoclaving as the cap or the vessel may get shattered due to the vacuum resulting from the cooling of the steam in the vessel. This is particularly important for larger vessels. Caps with liners may have their liner sucked into the vessel if the cap on the vessel opening is not loose enough.
- Do not put hot glassware, especially large bottles, from an Autoclave (or any other heat source) on to a cold bench top. The stress that is induced will often cause the base of the vessel to crack or fall off, releasing its hot contents.
- For non-liquid loads, please allow the glassware to cool for 15 minutes before touching it with ungloved hands.
- For liquid loads, please allow the liquid to stand for a full hour before touching the glassware with ungloved hands. Ensure that others in the vicinity are aware of the presence of a heat hazard.

## Cleaning validation of laboratory glassware:

As per USP – NF General Chapter 1051 (Cleaning Glass Apparatus), it is important to verify that the cleaning procedure is appropriate for the particular test or assay being undertaken. This can be accomplished in a number of ways, including use of experimental controls or verification of cleaning by utilization of residue/ residual testing to ensure removal of any potential contaminants.

It is recommended that Cleaning Validation of the laboratory glassware is to be performed once in a year to ensure effectiveness of cleaning procedure to remove residue of drug substances as well as cleaning agent used.

Borosil can help you by providing a validated analytical method for traces of **Vetroclean** (Borosil product code 9001033) along with complete validation protocol.





# INDEX

## Beakers

Page 25 - 27



## Bottles

Page 28 - 45



## Burettes

Page 46 - 57



## Cones

Page 58 - 59



## Condensers

Page 61 - 63



## Cylinders

Page 64 - 73



## Dessicators

Page 74 - 75



## Dishes

Page 77 - 79



## Distilling Apparatus

Page 80 - 85



## Water Distillation Unit

Page 86 - 90



## Apparatus

Page 92 - 98



## Mansingh Survisometer & Visocmeter

Page 99



## Extraction Apparatus

Page 100 - 101



## Flasks

Page 102 - 129



## Filtration Assembly

Page 130 - 134



## Volumetric Flask

Page 135 - 149



## Funnels

Page 151 - 155



## Gas Generator

Page 156



# INDEX



**Jars**  
Page 156



**Kettles**  
Page 157 - 158



**Pipettes**  
Page 159 - 167



**Weighing Scoop**  
Page 168



**Tubes**  
Page 168 - 171



**Adapters**  
Page 173 - 181



**Test Tubes /  
Culture Tubes**  
Page 184 - 190

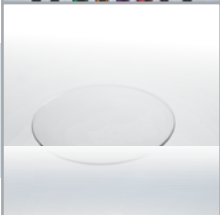

**Watch Glasses**  
Page 191



**Sintered Ware**  
Page 192 - 196



**Quartz ware**  
Page 197 - 201



**Chromatography  
Vials**  
Page 203 - 217



**Microscope slides  
& Cover Glass**  
Page 218 - 220



**Vetro Clean**  
Page 221



**Lab Accessories**  
Page 222 - 226



**Laboratory  
Equipment**  
Page 227 - 247



**Liquid Handling  
Systems**  
Page 248 - 259



**Disposable Tips  
& MCT**  
Page 260 - 265

# Did You Know?



## Beaker

the common low form beaker with spout was devised by John Griffin and also called "Griffin Beaker"

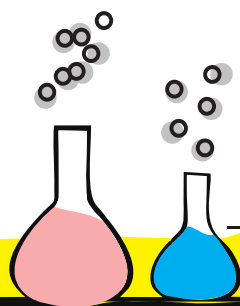

**BOROSIL®**

# Beakers

Whether it is research, industry or education, the Beaker has a wide range of applications. This simple container, used for stirring and mixing liquids, is also ideal for heating them. Controlled wall thickness at the sides, radius and the base, ensures a fine balance between the thermal resistance and mechanical strength, to enable effective heating. Many Beakers also have a spout that makes pouring easier and more precise.

**BOROIL** Glassware are best-in-class product with several advantages. It has a high level of thermal shock resistance and a high operating temperature. Besides using USP Type I borosilicate glass constant quality control checks are conducted throughout the production process to ensure uniformity of the wall thickness. Such uniform wall thickness distribution prevents uneven expansion and stressing of the glass that often result in a failure.

Beakers are mainly used as heating vessels. The tall-shape design of the Beaker is ideal for heating in a liquid bath, especially when the contents need to be kept distinctly apart from the surrounding medium or materials.

**BOROSIL**<sup>®</sup> brand Low form Beaker (Cat No. 1000) and **BOROSIL**<sup>®</sup> brand Tall Form Beaker (Cat No. 1060) are two popular styles used for storage and mixing.

**BOROSIL**<sup>®</sup> offers full range of beakers to suit every applications.



## 1000 - Beakers, Griffin, Low Form, with spout

- Complies with IS 2619 / ISO 3819 and DIN 12331
- The spout design enables clean and precise pouring
- Uniform wall thickness distribution makes it ideal for heating liquids
- The easy-to-read scale and large labelling field makes marking easier
- High resistance to chemical attack

Product Code	Capacity ml	Approx O.D. x Height mm	Quantity Per Case
1000005	5*	22 x 30	20
1000006	10*	26 x 35	20
1000009	25	34 x 50	60
1000D12	50	42 x 60	60
1000D16	100	50 x 70	40
1000D18	150	60 x 80	40
1000D21	250	70 x 95	40
1000D23	400	80 x 110	40
1000D24	500**	83 x 115	40
1000D25	600	90 x 125	40
1000028	800	100 x 135	20
1000D29	1000	105 x 145	20
1000D30	2000	130 x 185	6
1000D31	3000	150 x 210	4
1000D33	5000	170 x 270	4
1000D38	10000**	220 x 350	1

25ml to 10000ml Graduated.

\* 5 ml and 10 ml Beakers are not graduated.

\*\*500 & 10000 ml not covered in IS, ISO and DIN standards.

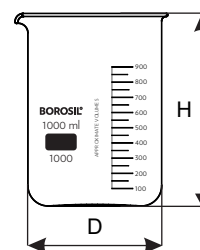

## 1006 - Beaker, Tablet Disintegration

- It has a large labelling field that enables easy marking
- Specially designed for Tablet disintegration machine

Product Code	Capacity ml	Approx O.D. x Height mm	Quantity Per Case
1006029	1000	105 x 145	10

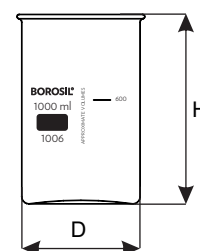

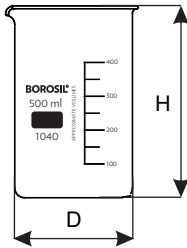

### 1040 - Beakers, Tall form, Without Spout

- Complies with IS 2619 / ISO 3819 and DIN 12331
- Graduated to indicate the approximate content
- The easy-to-read scale and large labelling field make marking easier
- Uniform wall thickness distribution makes it ideal for heating liquids
- This beaker is designed without a pouring spout

Product Code	Capacity ml	Approx O.D. x Height mm	Quantity Per Case
1040012	50	38 x 70	40
1040016	100	48 x 80	40
1040018	150	54 x 95	40
1040021	250	60 x 120	40
1040024	500*	77 x 137	20
1040025	600	80 x 150	20
1040028	800	90 x 175	20
1040029	1000	95 x 180	20

\* 500 ml not covered in IS, ISO and DIN.

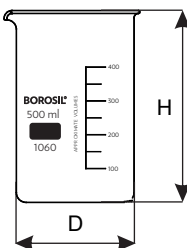

### 1060 - Beaker, Tall Form, With Spout

- Complies with IS 2619 / ISO 3819 and DIN 12331
- Uniform wall thickness distribution makes it ideal for heating liquids
- Graduated to indicate the approximate content
- All sizes are equipped with a durable matt-finished enameled space for marking
- This Beaker is designed with a pouring spout

Product Code	Capacity ml	Approx O.D. x Height mm	Quantity Per Case
1060012	50	38 x 70	40
1060D16	100	48 x 80	40
1060018	150	54 X 95	40
1060D21	250	60 x 120	40
1060D24	500*	77 x 137	20
1060025	600	80 x 150	20
1060028	800	90 x 175	20
1060D29	1000	95 x 180	20

\* 500 ml not covered in IS, ISO and DIN.

## 1080 - Beakers, Philips (Conical) with Spout

- Its mouth is smaller in diameter than its base
- The Phillips Beaker is ideal for measuring, containment, mixing and decanting
- Conical shape (Phillips pattern) with spout
- Excellent thermal performance and chemical resistance

Product Code	Capacity ml	Approx O.D. x Height mm	Quantity Per Case
1080021	250	68 x 110	40
1080024	500	88 x 145	40

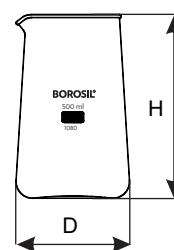

## TONGS FOR BEAKERS & FLASKS

- Made of stainless steel
- Used to handle hot beakers
- Provided with silicon sleeves or in fibre glass yarn to resist direct flame

Description	Size Inches	Caselot
Beaker Tong	10	6
Beaker Tong	12	6
Flask Tong	10	6

for more details please refer **page no. 222**



# Bottles

Bottles have multiple uses, as the Aspirator, Reagent and Solution Bottles. Bottles are not used for direct heating purposes, as they are designed with heavier wall thickness, making them mechanically stronger to withstand wet or dry sterilisation. The high chemical durability of the glass ensures that most reagents can be stored in these bottles for long durations in almost the same condition. Plain Neck Solution Bottles are designed to have a uniform rubber stopper fit. Roux Bottles have flat surfaces and are widely used for culture growth.

The outstanding **BOROSIL®** quality provides capabilities for a wider range of functions, from long-term storage to the most demanding applications in the pharmaceutical industry.





## 1220 - Bottle, Aspirator, with GL 45 Cap and tubulation

- Complies with IS 1388 (Part III), EN ISO 4796-3
- Complete with PP screw cap and pouring ring
- Suitable for storage of aggressive media
- All sizes have a durable matt-finished enamelled area for marking

Product Code	Capacity ml	Approx O.D. x Height* mm	Thread Specification	Quantity Per Case
1220021	250**	70 x 138	GL 45	10
1220024	500**	86 x 176	GL 45	10
1220029	1000	101 x 225	GL 45	10
1220030	2000	136 x 260	GL 45	5
<b>NEW</b> 1220033	5000	181 x 323	GL 45	1
<b>NEW</b> 1220038	10000	235 x 405	GL 45	1
<b>NEW</b> 1220040	20000	296 x 500	GL 45	1

\*\*Not covered in ISO / DIN standards.

\*Height indicated is of Bottle only

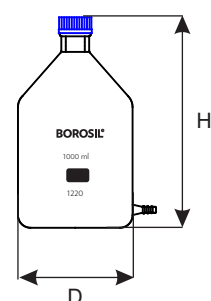

## 1240 - Bottle, Aspirator, with GL-45 Cap and socket

- Complies with IS 1388 (Part III), EN ISO 4796-3
- Complete with PP screw cap and pouring ring
- Suitable for storage of aggressive media
- All sizes have a durable matt-finished enamelled area for marking

Product Code	Capacity ml	Approx O.D. X Height* mm	Thread Specification	Outlet Ground Joint Size	Quantity Per Case
1240029	1000	101 x 225	GL 45	24 / 29	10
1240030	2000	136 x 260	GL 45	29 / 32	5
1240033	5000	181 x 323	GL 45	29 / 32	1
1240038	10000	235 x 405	GL 45	29 / 32	1
<b>NEW</b> 1240040	20000	296 x 500	GL 45	29 / 32	1

\*Height indicated is of Bottle only

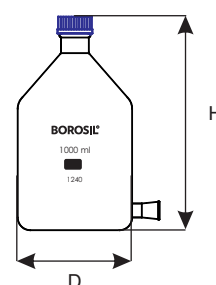

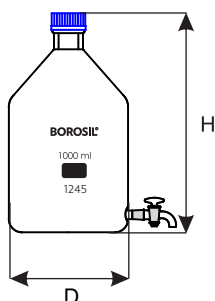

### 1245 - Bottle, Aspirator, with GL 45 Cap and Interchangeable Stopcock

- Complies with IS 1388 (Part III), EN ISO 4796-3
- Complete with PP screw cap and pouring ring
- Suitable for storage of aggressive media
- All sizes have a durable matt-finished enamelled area for marking
- Dosing of liquids via stopcock

Product Code	Capacity ml	Approx O.D. X Height* mm	Thread Specification	Outlet Ground Joint Size	Quantity Per Case
1245029	1000	101 x 225	GL 45	24 / 29	10
1245030	2000	136 x 260	GL 45	29 / 32	4
1245033	5000	181 x 323	GL 45	29 / 32	1
1245038	10000	227 x 410	GL 45	29 / 32	1
1245040	20000	296 x 500	GL 45	29 / 32	1

\*Height indicated is of Bottle only

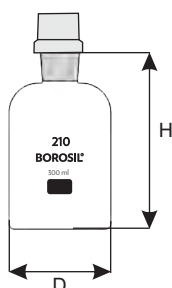

### 1250 - Bottles, B.O.D. with Interchangeable Stopper and plastic cap

- Complies with IS 9213
- Used for determination of B.O.D. in industrial effluents, waste and water
- Provided with plastic cap to avoid vapours
- Individual number printed on the bottle

Product Code	Capacity ml	Approx O. D. x Height* mm	Quantity Per Case
1250013	60**	42 x 100	10
1250017	125**	55 x 120	10
1250022	300	70 x 143	30

\*Height indicated is of Bottle only

\*\* 60 & 125 ml are not covered in standards

300 ml is for determination of B.O.D. in Industrial effluents, wastes and water as per method specified by the American Public Health Association and is numbered individually.

## 1290 - Bottles, Culture, Roux, Off-Set Neck

- Complies with IS 6942
- The offset neck is tool-finished for greater strength and uniform stopper fit
- These bottles facilitate the growing of mass cultures and single or monolayer cultures
- It withstands repeated sterilisation (wet or dry)

Product Code	Capacity ml	Approx b x w x h mm	Approx Neck I. D. mm	Quantity Per Case
1290029	1000	126 x 56 x 265	26	20



## 136N - Bottles, McCartney Flat, With Aluminium Screw Cap & Rubber Liner, Neutral

- Autoclavable
- Neutral Glass
- Leak Proof clear glass bottle
- With aluminium screw cap with rubber liner

Product Code	Capacity ml	Approx Width x Breadth x Height mm	Quantity Per Case
0136041	210	63 x 40 x 150	50

The McCartney bottles are used to carry culture medium and bacterial growth in Diagnosis Laboratories, Microbiological Laboratories, Biological Laboratories and Chemical Laboratories.

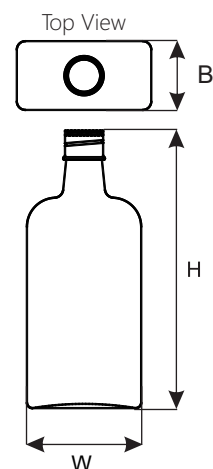

## Borosil Reagent Bottle

Borosil Laboratory bottles are chemically resistant and stable. When fitted with a plastic pouring ring dripping can be totally eliminated. As there is only one size of screw thread for all bottles from 100 ml onwards, the screw caps and pouring rings are fully interchangeable. The bottles, pouring rings and caps are autoclavable and sterilizable.

### Properties :

#### Light protection :

- Amber bottles are opaque upto 500 nm

#### Safe closure ensures storage of products as

- Dairy products
- Serums

#### High resistance to thermal shock (upto 140°C)

### HANDLING :

#### Sterilization :

Bottles can be steam sterilized after washing. Following are recommendation and guidelines.

- Soiled bottle must be clean first, otherwise microorganism cannot be effectively destroyed and chemicals adhering to surface can damage it as a result of high temperature involved.

- To avoid a buildup of pressure the screw cap should be left loose on the bottle neck (one turn maximum). It should not be closed tight as the pressure then cannot be balanced and consequent in pressure can result in bottle bursting.
- Ensure that saturated steam is used and that it has unhindered access to all contaminated places. This is the only way to achieve effective steam sterilization.

### Thawing frozen substances :

The frozen material can be thawed by immersing the bottle in liquid bath taking care that the temperature differences does not exceed 100 degree C. This will ensure that the frozen material heated uniformly from all sides without damaging the bottle. It can however also be thawed slowly so that the surface melts first, allowing the material to expand.

### Freezing substances

Recommendation: When freezing, always place the bottles at an angle approx. 45°C and do not fill to more than capacity (to increase surface area). Temperature limit - 40°C as the plastic caps and pouring ring do not withstand lower temperatures.



---

Borosil laboratory bottles are widely used because of consistent performance & better quality.

---

## 1500 - Bottles Reagent, Plain Narrow Mouth, Graduated with Inter-changeable Flat Head Stopper

- Complies with IS 1388 (Part II), EN ISO 4796 - 2
- These narrow mouth reagent storage bottles have a sturdy ground neck
- All sizes have a durable matt-finished enamelled area for marking
- These bottles are mechanically strong and chemical resistant
- Supplied with solid glass stopper

Product Code	Capacity ml	Approx O.D. x Height* mm	Neck Stopper Size	Quantity Per Case
1500013	60**	45 x 100	14 / 23	40
1500016	100	56 x 105	14 / 23	10
1500017	125**	56 x 120	19 / 26	50
1500021	250	70 x 120	19 / 26	10
1500024	500	86 x 180	24 / 29	10
1500029	1000	100 x 230	29 / 32	10
1500030	2000	136 x 255	29 / 32	10

- \*Height indicated is of Bottle only

- \*\* 60 & 125 ml is not covered in standards

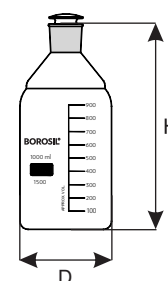

## 1501 - Bottles, Reagent, Graduated With Screw Cap and Pouring Ring

- Complies with IS 1388 (Part I), EN ISO 4796 - 1
- These bottles are mechanically strong and chemical resistant
- Designed with plastic pouring ring for drip-free operation
- The screw caps and pouring ring are made of PP
- The bottles, screw caps and pouring rings can be sterilized and autoclavable
- Printed with a Retrace Code
- 100 ml to 20000 ml Bottles have uniform GL 45 thread

Product Code	Capacity ml	Approx O.D. x Height* mm	Thread Specification	Quantity Per Case
1501006	10 <sup>##</sup>	36 X 50	GL 25	10
1501009	25 <sup>#</sup>	36 x 70	GL 25	20
1501012	50	46 x 87	GL 32	20
1501016	100	56 x 100	GL 45	10
1501018	150 <sup>##</sup>	60 x 120	GL 45	10
1501021	250	70 x 138	GL 45	10
1501024	500	86 x 176	GL 45	10
1501029	1000	101 x 225	GL 45	10
1501030	2000	136 x 260	GL 45	10
1501031	3000 <sup>**</sup>	158 x 295	GL 45	2
1501033	5000 <sup>***</sup>	183 x 323	GL 45	1
1501038	10000 <sup>***</sup>	235 x 405	GL 45	1
1501040	20000 <sup>***</sup>	296 x 500	GL 45	1

- \*Height indicated is of Bottle only

- # Without Pouring Ring

- \*\* Not covered in any standard

- \*\*\* As per Borosil Dimension

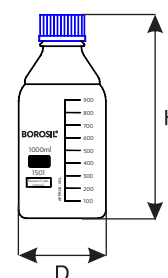

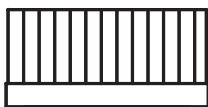

### 1503 - Screw Cap, with Pouring ring for Screw Cap Bottles

- Caps and pouring rings are made of PP (Polypropylene) and are auto-clavable upto 140°C

Product Code	Colour Description	Thread Specification	Quantity Per Case
1503C01	Blue	GL 45	10
1503C02	Orange	GL 45	10
1503C03	Yellow	GL 45	10
1503C04	Green	GL 45	10
1503C05	Grey	GL 45	10
1503C06	Blue	GL 25	10
1503C07	Blue	GL 32	10
1503C08	Blue	GL 36	10

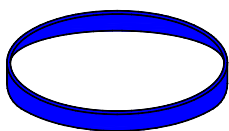

### 1504 - Pouring Ring, Blue Colour

- Pouring rings are made of PP (Polypropylene) and are autoclavable

Product Code	Colour Specification	Thread Specification GL	Quantity Per Case
1504R01	Blue	GL - 45	10

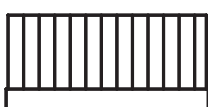

### 1505 - Red Screw Cap with Pouring ring for Laboratory bottles, auto-clavable upto 200°C

Product Code	Colour Specification	Thread Specification	Quantity Per Case
1505C01	Red	GL - 45	10

### 1506 - Bottles Reagent, Square with DIN Thread, Graduated, with PP Screw Cap (GL 80) and PP Pouring Ring

Product Code	Capacity ml	Approx W x B x H mm	Thread Specification Approx O.D. mm	Quantity Per Case
1506024	500	94 x 94 x 141	GL-80	10
1506029	1000	105 x 105 x 187	GL-80	10
1506030	2000	115 x 115 x 260	GL-80	10
1506033	5000	160 x 160 x 357	GL-80	1

\*Height indicated is of Bottle only

**Amber** colour bottles are available on request.

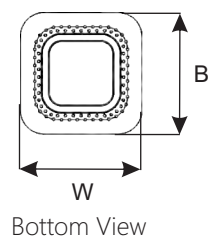
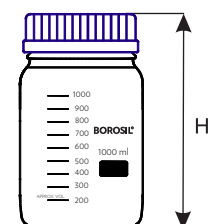

### 1508 - Bottles, Reagent, Wide Mouth, Graduated, with PP Screw Cap (GL 80) and PP Pouring Ring

Product Code	Capacity ml	Approx O.D. x Height* mm	Thread Specification Approx O.D. mm	Quantity Per Case
1508029	1000	101 x 220	GL- 80	10
1508030	2000	136 x 250	GL- 80	10
1508033	5000	183 x 315	GL- 80	1
1508038	10000	235 x 390	GL- 80	1
1508040	20000	296 x 485	GL- 80	1

\*Height indicated is of Bottle only

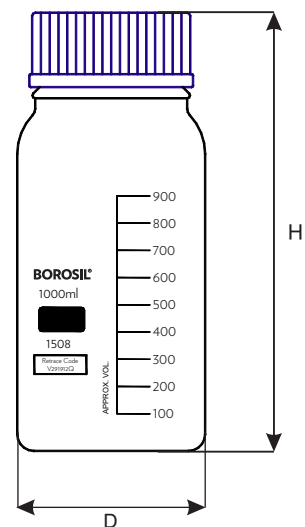

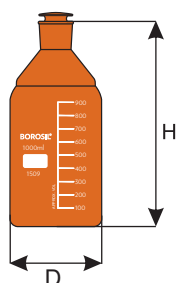

### 1509 - Bottles, Reagent, **Amber**, Narrow Mouth, Graduated, With Inter-changeable Flat Head Stopper

- Complies with IS 1388 (Part II), EN ISO 4796 - 2
- These narrow mouth reagent storage bottles have a sturdy ground neck
- All sizes have a durable matt-finished enamelled area for marking
- These bottles are mechanically strong and chemical resistant
- The uniform Amber colour is highly durable and has high chemical resistance
- Properties within the bottle remain unchanged, as the colour is applied only on the external surface
- Protects media from light radiation with a wave-length between 300 nm and 500 nm
- Ideal for use with light-sensitive media and for the long-term storage of substances
- Supplied with solid glass stopper

Product Code	Capacity ml	Approx O.D. x Height* mm	Neck Stopper Size	Quantity Per Case
1509013	60**	40 x 100	14 / 23	20
1509016	100	56 x 105	14 / 23	10
1509017	125**	56 x 120	19 / 26	20
1509021	250	70 x 140	19 / 26	10
1509024	500	86 x 182	24 / 29	10
1509029	1000	101 x 230	29 / 32	5
1509030	2000	136 x 255	29 / 32	5

- \*Height indicated is of Bottle only
- \*\* 60 & 125 ml is not covered in standards
- Similar in design to cat no. 1500

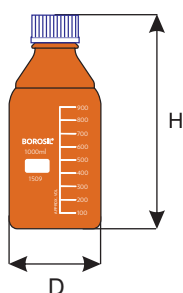

### 1519 - Bottles, Reagent, **Amber**, Wide Mouth, Graduated, With Screw Cap and Pouring Ring

- Complies with IS 1388 (Part I), EN ISO 4796 - 1
- These bottles are mechanically strong and chemical resistant
- Designed with plastic pouring ring for drip-free operation
- The screw caps and pouring are made of PP and autoclavable
- Printed with a Retrace Code
- The uniform Amber colour is highly durable and has high chemical resistance
- Properties within the bottle remain unchanged, as the colour is applied only on the external surface
- Ideal for use with light-sensitive media and for long-term storage of substances
- 100 ml to 20000 ml have uniform GL 45 thread

Product Code	Capacity ml	Approx O.D. x Height* mm	Thread Specification	Quantity Per Case
1519006	10**	#36 x 50	GL 25	10
1519009	25#	36 x 70	GL 25	20
1519012	50#	46 x 87	GL 32	20
1519016	100	56 x 100	GL 45	10
1519021	250	70 x 138	GL 45	10
1519024	500	86 x 176	GL 45	10
1519029	1000	101 x 225	GL 45	10
1519030	2000	136 x 260	GL 45	10
1519031	3000**	158 X 295	GL 45	2
1519033	5000***	183 x 323	GL 45	1
1519038	10000***	235 x 405	GL 45	1
1519040	20000***	296 x 500	GL 45	1

- # Without Pouring rings
- \*\*Not covered in any standard
- \*\*\*As per BOROSIL dimensions



## 1585 - Bottles, Solution, Plain, Tooled Neck

- These bottles are mechanically strong and chemical resistant
- 10, 20 & 50 litre bottles specially designed for handling and storing culture media
- All sizes have a durable matt-finished enamelled area for marking

Product Code	Capacity ml	Approx O.D. x Height mm	Approx Neck I. D. mm	Quantity Per Case
1585021	250	70 x 140	18	20
1585024	500	86 x 180	23	20
1585029	1000	101 x 230	28	10
1585030	2000	136 x 285	33	10
1585031	3000	158 x 255	44	4
1585033	5000	183 x 330	44	1
1585038	10000	235 x 430	54	1
1585040	20000	296 x 530	54	1
1585046	50000	417 x 665	89	1

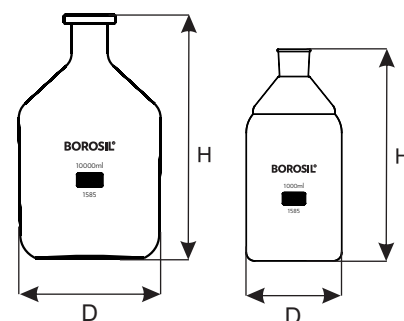

## 1589 - Bottles, Solution, Amber, Tooled Neck

- These bottles are mechanically strong and chemical resistant
- All sizes have a durable matt-finished enamelled area for marking
- The uniform Amber colour is highly durable and has high chemical resistance
- Properties within the bottle remain unchanged, as the colour is applied only on the external surface
- Protects media from light radiation with a wave-length between 300 nm and 500 nm
- Ideal for use with light-sensitive media and for long-term storage of substances

Product Code	Capacity ml	Approx O.D. x Height mm	Approx Neck I. D. mm	Quantity Per Case
1589021	250	70 x 140	18	10
1589024	500	86 x 180	23	20
1589029	1000	101 x 230	28	5
1589030	2000	136 x 255	33	5

Similar in design to Cat No. 1585

For Higher Capacities please contact our Head Office

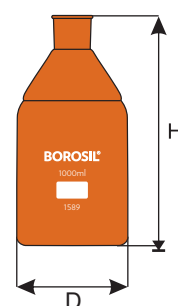



### 1624-Bottles, Relative Density, with Capillary Bore Interchangeable Teflon Stopper

- These bottles are mechanically strong and chemical resistant
- All sizes have a durable matt-finished enamelled area for marking
- Comes with a Works Certificate

Product Code	Capacity ml	Capacity Tolerance +ml	Max. Body Dia x Height mm	Size of Inter-Changeable Stopper	Quantity Per Case
1624006	10	0.3	29 x 48	10 / 15	5
1624009	25	0.8	40 x 55	10 / 15	5
1624012	50	1.0	50 x 65	10 / 15	5

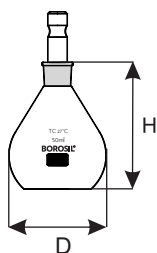

### 1625 - Bottles Relative density, with Capillary bore Interchangeable Teflon stopper

- Complies with IS 5717, DIN / ISO 3507
- These bottles are mechanically strong and chemical resistant
- All sizes have a durable matt-finished enamelled area for marking

Product Code	Capacity ml	Capacity Tolerance +ml	Max. Body Dia x Height mm	Size of Inter-Changeable Stopper	Quantity Per Case
1625006	10	1	29 x 48	10 / 15	10
1625009	25	2	40 x 55	10 / 15	10
1625012	50	3	50 x 65	10 / 15	5

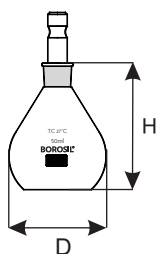

## 1627 - Bottles Specific , Gravity Bottle with thermometer (Pyknometer)

- Complies with IS 5717, DIN / ISO 3507
- These bottles are mechanically strong and chemical resistant
- All sizes have a durable matt-finished enamelled area for marking
- Supplied with thermometer alongwith certificate for thermometer

Product Code	Capacity ml	Quantity Per Case
1627006	10	5
1627009	25	5
1627012	50	5

Suitable for determining the density with built in thermometer & thermometer pocket.

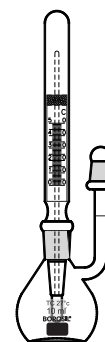

## 1630 - Bottles, Weighing, With Interchangeable Stopper

- Complies with IS 1574
- These bottles are mechanically strong and chemical resistant

Product Code	Capacity ml	Approx O.D. x Height* mm	Quantity Per Case
1630005	5	20 x 40	30
1630007	15	25 x 65	10
1630008	20**	50 x 35	10
1630009	25	30 x 65	10
1630011	40**	60 x 40	10
1630013	60	40 x 90	5

\*Height indicated is of Bottle only

\*\*Squat Form

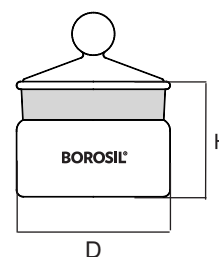

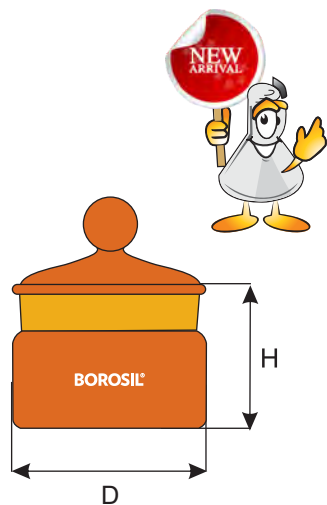

### 1631 - Bottles, Weighing, With Interchangeable Stopper, Amber

- Complies with IS 1574
- These bottles are mechanically strong and chemical resistant
- Suitable for light sensitive substance.

Product Code	Capacity ml	Approx O.D. x Height* mm	Quantity Per Case
1631005	5	20 x 40	30
1631007	15	25 x 65	10
1631008	20	50 x 35	10
1631009	25	30 x 65	10
1631011	40	60 x 40	10
1631013	60	40 x 90	5



### 1640 - Bottles, Dropping with Pipette & Rubber Teat

- Made from 3.3 borosilicate glass
- Highly chemical resistance
- Supplied with interchangeable ground joint transparent pipette with rubber teat

Product Code	Capacity ml	Approx O.D. x Height mm	Socket Size	Quantity Per Case
1640010	30	35 x 84	14 / 19	10
1640013	60	42 x 100	14 / 19	10
1640017	125	55 x 120	19 / 26	10
1640021	250	65 x 147	19 / 26	10

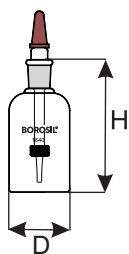

### 1650 - Bottles, Dropping with Pipette & Rubber Teat, Amber

- Made from 3.3 borosilicate glass
- Highly chemical resistance
- Supplied with interchangeable ground joint Amber pipette with rubber teat
- Ideal for light sensitive materials

Product Code	Capacity ml	Approx O.D. x Height mm	Socket Size	Quantity Per Case
1650010	30	35 x 84	14 / 19	10
1650013	60	42 x 100	14 / 19	10
1650017	125	55 x 120	19 / 26	10
1650021	250	65 x 147	19 / 26	10

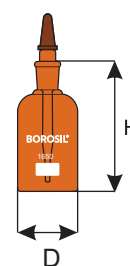
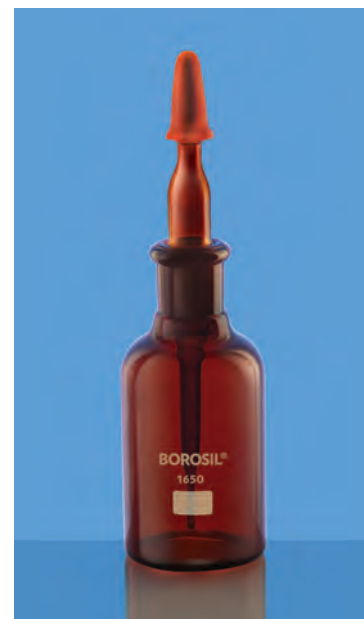

### 1660 - Bottles, Wash, Complete with Interchangeable Stopper

- These bottles are mechanically strong and chemical resistant
- All sizes have a durable matt-finished enamelled area for marking

Product Code	Capacity ml	Size of Inter-changeable Stopper	Quantity Per Case Set
1660021	250	24 / 29	5
1660024	500	24 / 29	5
1660029	1000	29 / 32	5

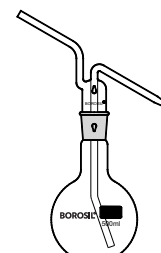



**1661 - Stoppers, Only For Wash Bottles Cat. No. 1660**

Product Code	Capacity ml	Size of Inter-changeable Stopper	Quantity Per Case
1661021	250	24 / 29	5
1661024	500	24 / 29	5
1661029	1000	29 / 32	5

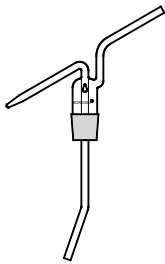

**1662 - Bottles, Only for Wash Bottles Cat No. 1660**

Product Code	Capacity ml	Approx Height mm	Size of Interchangeable Stopper	Quantity Per Case
1662021	250	130	24 / 29	5
1662024	500	160	24 / 29	5
1662029	1000	195	29 / 32	5

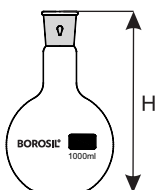

### 1665 - Plastic Clamp for Joint Fittings

Product Code	Joint mm	Quantity Per Case
1665B14	B 14	10
1665B19	B 19	10
1665B24	B 24	10
1665B29	B 29	10

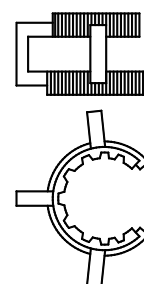

### 166P - Bottles, Wash, LDPE Plastic, Squeeze type, Screw Cap, Fitted With Stoppers and Delivery Tubes

- Bottles and delivery tube made of chemically resistant, low density polyethylene
- Flexible, tough, light weight, and practically unbreakable in use
- Squeezing the bottle produces a steady controllable stream or a few drops.
- Delivery tubes are mounted in polypropylene screw caps
- Tips on delivery tubes are removable

Product Code	Capacity ml	Approx Diameter mm	Bottle Height mm	Quantity Per Case
0166024	500	75	167	36

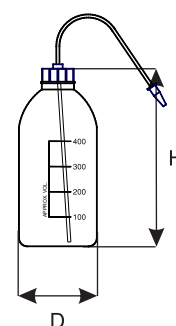



### 1760 - Bottles, Gas Washing (Dreschel), Complete with Interchangeable Stopper

- Complies with IS 11990
- These bottles are mechanically strong and chemical resistant
- All sizes have a durable matt-finished enamelled area for marking

Product Code	Capacity ml	Size of Inter-changeable Stopper	Quantity Per Case Set
1760017	125	29 / 32	5
1760021	250	29 / 32	5
1760024	500	29 / 32	5

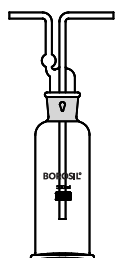

### 1761 - Stoppers, Only for Gas Washing Bottles

Product Code	Capacity ml	Quantity Per Case
1761017	125	5
1761021	250	5
1761024	500	5

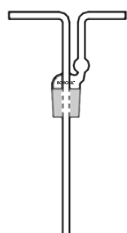

### 1762 - Bottles, Only for Gas Washing Bottles

Product Code	Capacity ml	Approx O. D. x Height mm	Quantity Per Case
1762017	125	50 x 165	5
1762021	250	60 x 190	5
1762024	500	70 x 245	5

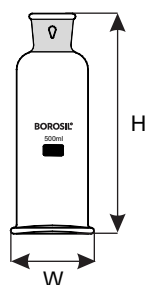



## 1764 - Tubes, Gas Sampling, with Stopcocks

- Complies with DIN 12473

Product Code	Capacity ml	Quantity Per Case
1764017	125*	10
1764021	250*	10
1764024	500	10
1764029	1000	10

\*Not covered in standards



## 1765 - Impinger

- Complies with IS 5182 (Part-VI)
- These bottles are mechanically strong and chemical resistant

Product Code	Capacity ml	Approx O. D. x Height mm	Quantity Per Case Set
1765058	35	26 x 220	10

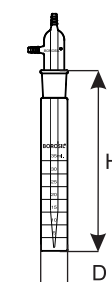

# Burettes

- Manufactured from 3.3 Low Expansion Borosilicate I.D. control tubing.
- Individually calibrated by automatic calibration process
- Stringent quality control through all steps to eliminate possible deviations from nominal volume
- Individual certificate can be downloaded from our website
- Graduation and inscriptions are printed with white enamel
- Comes with highest quality standards according to **IS 1997** and **ISO 385**
- Supplied with PTFE stopcock, Boroflo stopcock and Straight Bore Glass Stopcock



Accuracy, reliability and durability are the essential of a Burette. Only Borosil brand Burettes offer you these three benefits even after repeated usage, as they are made with a combination of the best material and workmanship. The highest quality accurate bore tubing is selected to provide uniform and accurate graduations. Each burette is individually calibrated on a fully automatic machine for precision and high accuracy. All graduations are marked in durable white enamel. The stopcock plugs are not interchangeable.

In addition to Burettes with glass stopcocks, Borosil offers Burettes with straight bore PTFE stopcocks and a range of Boroflo Burettes fitted with Boroflo (GP) screw thread stopcocks with PTFE keys.

Boroflo Burettes fitted with Boroflo GP (General Purpose) screw thread stopcocks with PTFE keys offer the following operationla advantages :

- Lubrication is never required, ensuring no seizure and no contaminating greases.
- Excellent flow control that is important for Burettes
- All-glass / PTFE pathway, highly resistant to chemical attack
- The unique Fluon/glass seal ensures no leakage
- No springs or retaining devices makes it easy to dismentle and clean them
- Absence of ground surfaces results in low absorption of radioactivity
- Consistent performance between 0°C and 50°C

Borosil offers Class A Burette for accurate work



- Boroflo stopcocks have PTFE keys which do not require greasing
- This PTFE keys provide best drop control during titration process
- Due to identical shape of PTFE key it Burette valve can be closed with gentle turn.
- PTFE stopcocks have identical keys, hence matching the pairs is not require during cleaning
- PTFE is self lubricating hence keys
- do not require greasing
- Specially designed solid glass stopcocks are manufactured from 3.3 Low expansion borosilicate glass
- Glass stopcock are perfectly grind , hence no leakage occur.



### 2121- Burettes, Boroflo, Fitted With Boroflo GP (General Purpose), Screw Thread with PTFE Keys, Accuracy as per Class A of IS 1997:2008/EN ISO 385, with Batch Certificate

- Generally used in Titration process
- Comes with Boroflo with PTFE key that is highly resistant to chemical attack
- No need to lubricate it as PTFE key is used

Product Code	Capacity ml	Graduation Interval ml	Tolerance $\pm$ ml	Quantity Per Case
2121006A	10	0.05	0.03	5
<b>NEW</b> 2121U06A*	10	0.02	0.02	5
2121009A	25	0.10	0.05	5
<b>NEW</b> 2121U09A*	25	0.05	0.03	5
2121012A	50	0.10	0.05	5
2121016A	100	0.20	0.10	5

\* Accuracy as per ASTM E 287-2

\* Individually calibrated certificate can be provided on request.

### 2122 - Burettes Boroflo, Fitted With Boroflo GP (General Purpose), Screw Thread with PTFE Keys, Accuracy as per Class B of IS 1997:2008/EN ISO

- Generally used in Titration process
- Comes with Boroflo with PTFE key that is highly resistant to chemical attack
- No need to lubricate it as PTFE key is used

Product Code	Capacity ml	Graduation Interval ml	Tolerance $\pm$ ml	Quantity Per Case
2122006D	10	0.05	0.05	5
2122009D	25	0.10	0.10	5
2122012D	50	0.10	0.10	5
2122016D	100	0.20	0.20	5



## 2123 - Burettes, Straight Bore Stopcock, Boroflo, Accuracy as per Class A of IS 1997:2008/EN ISO 385, with Batch Certificate

- Generally used in Titration process
- Designed with straight bore stopcock that increases the life, compared to PTFE key stopcocks
- The glass stopcock enhances control and enables smoother action
- The tolerance conforms to Class A of IS and ISO

Product Code	Capacity ml	Graduation Interval ml	Tolerance $\pm$ ml	Quantity Per Case
2123005A	5	0.02	0.01	5
2123006A	10	0.05	0.03	5
2123009A	25	0.10	0.05	5
2123012A	50	0.10	0.05	5
2123016A	100	0.20	0.10	5

\* Individually calibrated certificate can be provided on request.

## 2124 - Burettes, Straight Bore Stopcock, Boroflo, Accuracy as per Class B of IS 1997:2008/EN ISO 385

- Generally used in Titration process
- Designed with straight bore stopcock that increases the life, compared to PTFE key stopcocks
- The glass stopcock enhances control and enables smoother action
- The tolerance conforms to Class B of IS and ISO

Product Code	Capacity ml	Graduation Interval ml	Tolerance $\pm$ ml	Quantity Per Case
2124005D	5	0.02	0.02	5
2124006D	10	0.05	0.05	5
2124009D	25	0.10	0.10	5
2124012D	50	0.10	0.10	5
2124016D	100	0.20	0.20	5

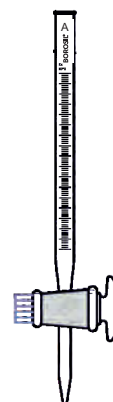



**2129-Burettes, Straight Bore Stopcock PTFE Key Stopcock, Accuracy as per Class A of IS 1997:2008/EN ISO 385, with Batch Certificate**

- Generally used in Titration process
- Comes with PTFE key that is highly resistant to chemical attack
- No need to lubricate it as PTFE key is used

Product Code	Capacity ml	Graduation Interval ml	Tolerance $\pm$ ml	Quantity Per Case
2129006A	10	0.10	0.05	5
2129U06A	10	0.02	0.02	5
2129009A	25	0.10	0.05	5
2129U09A	25	0.05	0.03	5
2129012A	50	0.10	0.05	5
2129016A	100	0.10	0.05	5

- Blue enamel inscription can be supplied on request
- Individual calibration certificate can be provided on request

**2130-Burettes, Straight Bore Stopcock PTFE Key Stopcock, Accuracy as per Class B of IS 1997:2008/EN ISO 385**

- Generally used in Titration process
- Comes with PTFE key that is highly resistant to chemical attack
- No need to lubricate it as PTFE key is used
- The volume content tolerance conforms to Class B of IS and ISO

Product Code	Capacity ml	Graduation Interval ml	Tolerance $\pm$ ml	Quantity Per Case
2130006D	10	0.10	0.05	5
2130009D	25	0.10	0.05	5
2130012D	50	0.10	0.1	5
2130016D	100	0.10	0.1	5

- Blue enamel inscription can be supplied on request

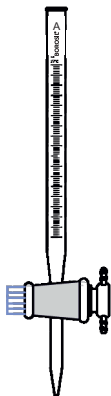

**2003 - Burettes, Straight Bore Stopcock, PTFE key stopcock Accuracy as per class A, ISO 385, with Certificate, NABL Certified**

- Complies with IS 1997, EN ISO 385

Product Code	Capacity ml	Graduation Interval	Tolerance $\pm$ ml	Quantity Per Case
2003006	10	0.1	0.05	5
2003009	25	0.1	0.05	5
2003012	50	0.1	0.05	5
2003016	100	0.1	0.05	5

**2131 - Burettes, Boroflo, Fitted With Boroflo GP (General Purpose), Screw Thread Stopcock With PTFE Keys, Accuracy as per Class A of IS 1997:2008/EN ISO 385, with Batch Certificate, Amber**

- Generally used in Titration process
- Comes with PTFE key that is highly resistant to chemical attack
- No need to lubricate it as PTFE key is used
- The volume content tolerance conforms to Class A of ISO
- Amber colour is applied to the external surface to prevent contamination with the testing material

Product Code	Capacity ml	Graduation Interval ml	Tolerance $\pm$ ml	Quantity Per Case
2131009A	25	0.10	0.05	5
2131012A	50	0.10	0.05	5

\* Individually calibrated certificate can be provided on request.

**2132 - Burettes, Boroflo, Fitted With Boroflo GP (General Purpose), Screw Thread Stopcock With PTFE Keys, Accuracy as per Class B of IS 1997:2008/EN ISO 385, Amber**

- Generally used in Titration process
- Comes with PTFE key that is highly resistant to chemical attack
- No need to lubricate it as PTFE key is used
- The volume content tolerance conforms to Class B of IS and ISO

Product Code	Capacity ml	Graduation Interval ml	Tolerance $\pm$ ml	Quantity Per Case
2132009D	25	0.10	0.10	5
2132012D	50	0.10	0.10	5



**NABL  
CERTIFIED**

**2004 - Burettes, Straight Bore PTFE key stopcock Accuracy as per Class A ASTM E:287, with certificate NABL certified, Amber**

- Complies with IS 1997, EN ISO 385

Product Code	Capacity ml	Graduation Interval	Tolerance $\pm$ ml	Quantity Per Case
2004U06	10	0.02	0.02	5
2004U09	25	0.05	0.03	5
2004U12	50	0.1	0.05	5
2004U16	100	0.1	0.05	5

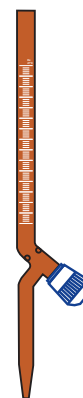

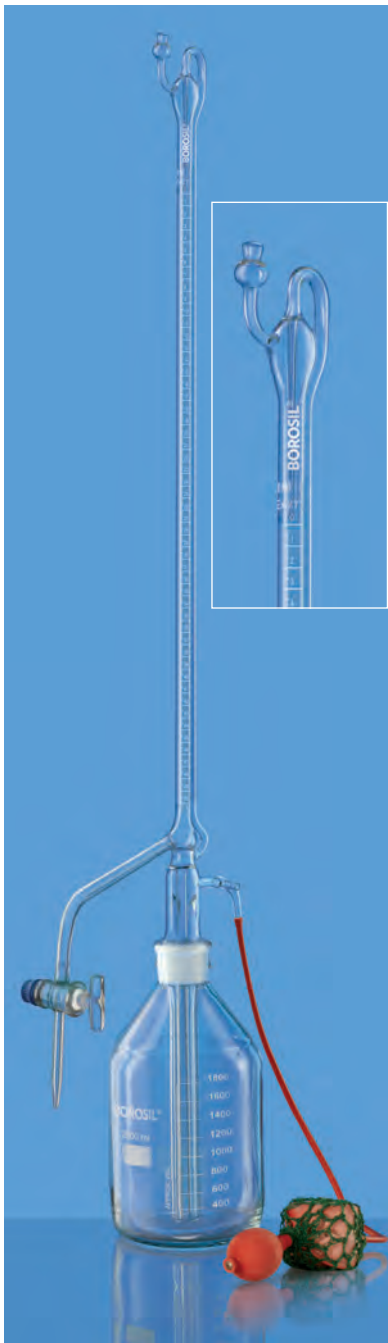

### 2149-Burettes, Automatic Zero, Accuracy as per Class A of IS 1997:2008/EN ISO 385, with Reservoir, Rubber Bellow, Glass Stopcock, With Certificate

- Complies with IS 1997, EN ISO 385
- With automatic zero facility
- Individually tested for exact volume dispensed at 3 points on the scale
- Alpha numeric serial number on the article and certificate provide complete traceability
- Simple operation
  - To fill Burette apply a slight positive pressure to lower side arm
  - To set zero, release pressure to allow excess liquid to siphon back into the bottle
- Burettes manufactured from chemically resistant 3.3 borosilicate glass
- White enamel graduations
- With Glass stopcock

Product Code	Capacity ml	Graduation Interval ml	Tolerance $\pm$ ml	Quantity Per Case
2149006D	10	0.05	0.03	1
2149009D	25	0.10	0.05	1
2149012D	50	0.10	0.05	1
2149016D	100	0.20	0.10	1

Reservoir Capacity : 500 ml for 10 ml size and 2000 ml for 25, 50 and 100 ml sizes.

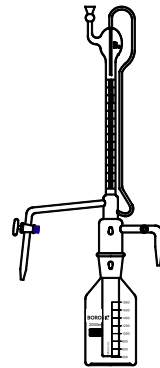



**2149A-Burettes, Automatic Zero, Accuracy as per Class A of IS 1997:2008/EN ISO 385, with Reservoir, Rubber Bellow, Glass Stopcock, Amber With Certificate**

- Complies with IS 1997, EN ISO 385
- With automatic zero facility
- Individually tested for exact volume dispensed at 3 points on the scale
- Alpha numeric serial number on the article and certificate provide complete traceability
- Simple operation
  - To fill Burette apply a slight positive pressure to lower side arm
  - To set zero, release pressure to allow excess liquid to siphon back into the bottle
- Burettes manufactured from chemically resistant 3.3 borosilicate glass
- White enamel graduations
- With Glass stopcock

Product Code	Capacity ml	Graduation Interval ml	Tolerance $\pm$ ml	Quantity Per Case
2149A06D	10	0.05	0.03	1
2149A09D	25	0.10	0.05	1
2149A12D	50	0.10	0.05	1
2149A16D	100	0.20	0.10	1

Reservoir Capacity : 500 ml for 10 ml size and 2000 ml for 25, 50 and 100 ml sizes.

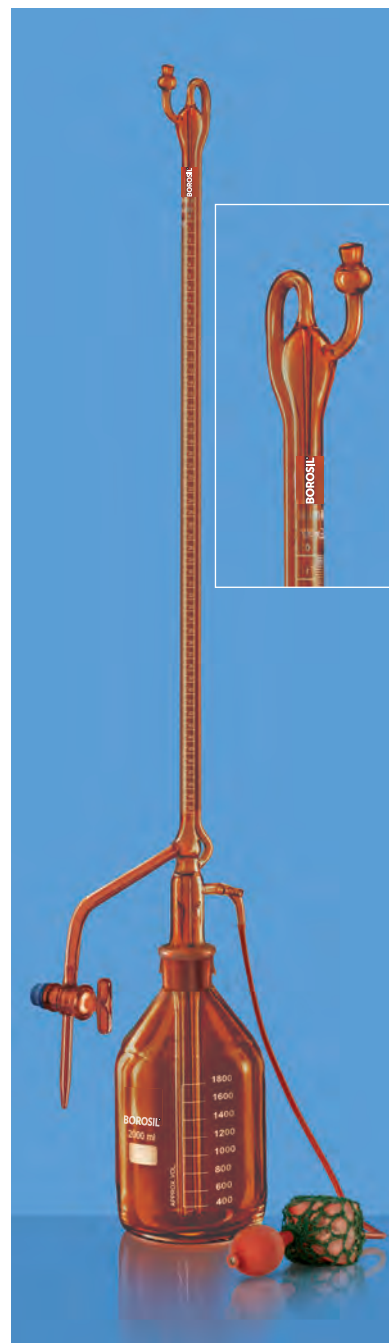
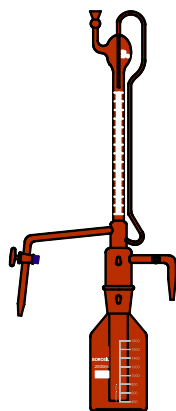

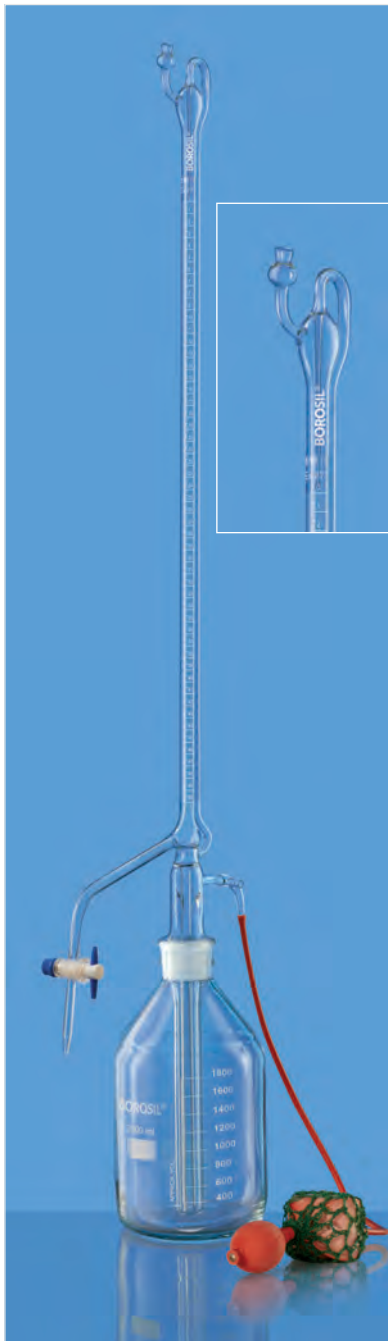

### 2153 - Burettes, Automatic Zero, Accuracy as per Class A of IS 1997:2008/EN ISO 385, with Reservoir, Rubber Bellow, PTFE Stopcock, With Certificate

- Complies with IS 1997, EN ISO 385
- With automatic zero facility
- Individually tested for exact volume dispensed at 3 points on the scale
- Alpha numeric serial number on the article and certificate provide complete traceability
- Simple operation
  - To fill Burette apply a slight positive pressure to lower side arm
  - To set zero, release pressure to allow excess liquid to siphon back into the bottle
- Burettes manufactured from chemically resistant 3.3 borosilicate glass
- White enamel graduations
- With Glass stopcock

Product Code	Capacity ml	Graduation Interval ml	Tolerance $\pm$ ml	Quantity Per Case
2153006D	10	0.05	0.03	1
2153009D	25	0.10	0.05	1
2153012D	50	0.10	0.05	1
2153016D	100	0.20	0.10	1

Reservoir Capacity : 500 ml for 10 ml size and 2000 ml for 25, 50 and 100 ml sizes.

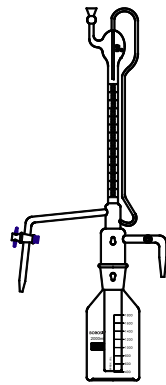

**2153A - Burettes, Automatic Zero, Accuracy as per Class A of IS 1997: 2008/EN ISO 385, with Reservoir, Rubber Bellow, PTFE Stopcock, Amber With Certificate**

- Complies with IS 1997, EN ISO 385
- With automatic zero facility
- Individually tested for exact volume dispensed at 3 points on the scale
- Alpha numeric serial number on the article and certificate provide complete traceability
- Simple operation
  - To fill Burette apply a slight positive pressure to lower side arm
  - To set zero, release pressure to allow excess liquid to siphon back into the bottle
- Burettes manufactured from chemically resistant 3.3 borosilicate glass
- White enamel graduations
- With Glass stopcock

Product Code	Capacity ml	Graduation Interval ml	Tolerance $\pm$ ml	Quantity Per Case
2153A06D	10	0.05	0.03	1
2153A09D	25	0.10	0.05	1
2153A12D	50	0.10	0.05	1
2153A16D	100	0.20	0.10	1

Reservoir Capacity : 500 ml for 10 ml size and 2000 ml for 25, 50 and 100 ml sizes.

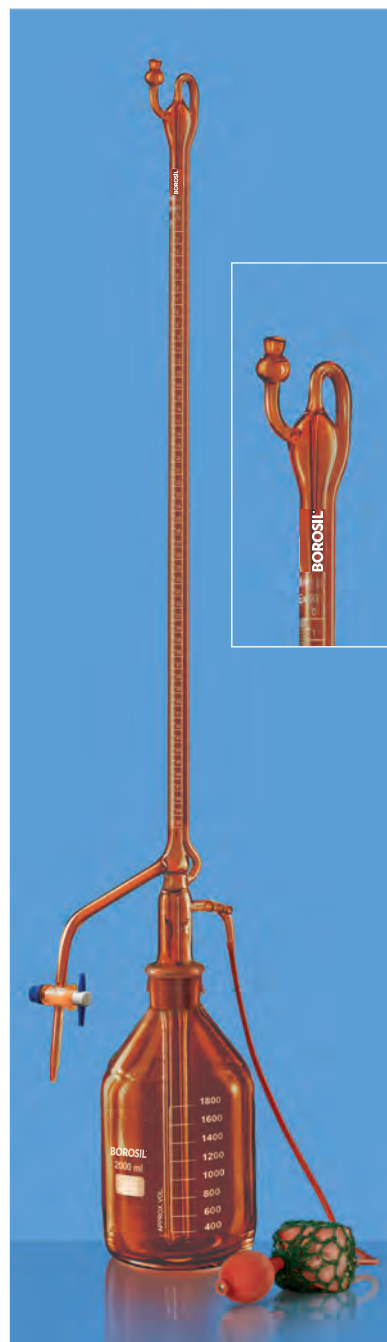
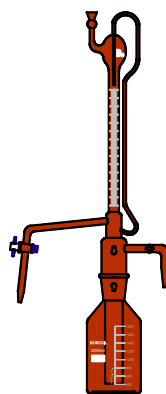

## 2155 - Burettes, Automatic Zero, Accuracy as per Class A of IS 1997:2008/EN ISO 385, with Reservoir, Rubber Bellow and Boroflo Stopcock, With Certificate

- Complies with IS 1997, EN ISO 385
- With automatic zero facility
- Individually tested for exact volume dispensed at 3 points on the scale
- Alpha numeric serial number on the article and certificate provide complete traceability
- Simple operation
  - To fill Burette apply a slight positive pressure to lower side arm
  - To set zero, release pressure to allow excess liquid to siphon back into the bottle
- Burettes manufactured from chemically resistant 3.3 borosilicate glass
- White enamel graduations
- With Glass stopcock

Product Code	Capacity ml	Graduation Interval ml	Tolerance $\pm$ ml	Quantity Per Case
2155006D	10	0.05	0.03	1
2155009D	25	0.10	0.05	1
2155012D	50	0.10	0.05	1
2155016D	100	0.20	0.10	1

Reservoir Capacity : 500 ml for 10 ml size and 2000 ml for 25, 50 and 100 ml sizes.

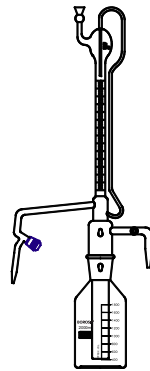
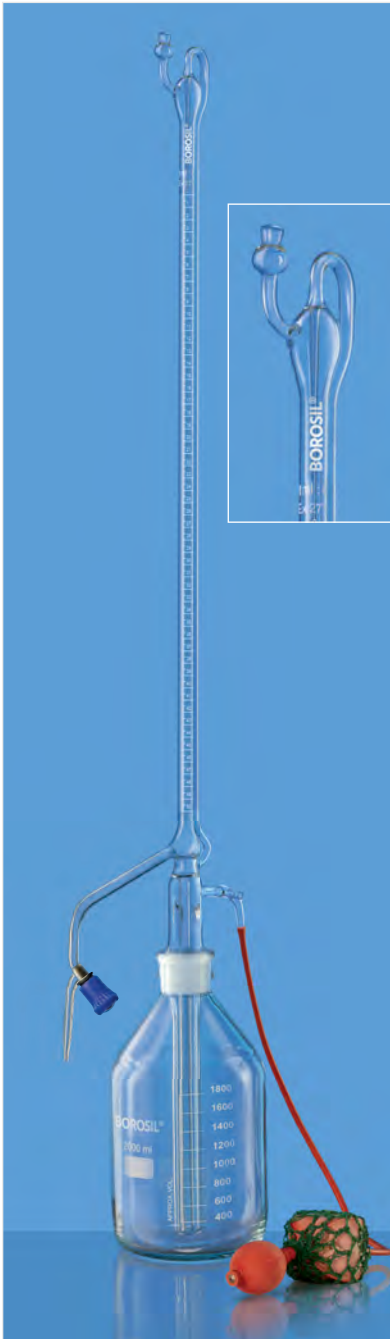

2155A - Burettes, Automatic Zero, Accuracy as per Class A of IS 1997: 2008/EN ISO 385, with Reservoir, Rubber Bellow and Boroflo Stopcock, Amber With Certificate

Product Code	Capacity ml	Graduation Interval ml	Tolerance $\pm$ ml	Quantity Per Case
2155A06D	10	0.05	0.03	1
2155A09D	25	0.10	0.05	1
2155A12D	50	0.10	0.05	1
2155A16D	100	0.20	0.10	1

Reservoir Capacity : 500 ml for 10 ml size and 2000 ml for 25, 50 and 100 ml sizes.

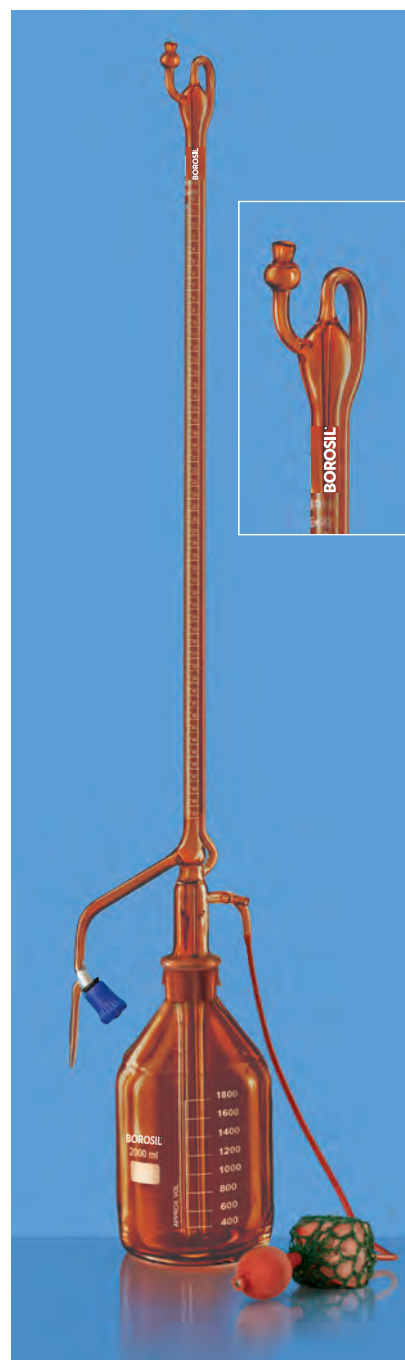
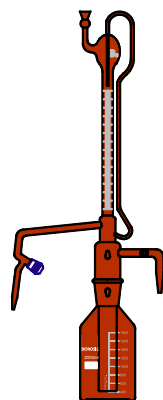

# Cones

Cones are used to determine small amounts of suspended matter in sewage by the Imhoff Sedimentation Method.



## 2160 - Cones, Imhoff, Sediment, Sharp Tip

- Complies with IS 7232
- Graduated from 0 to 1 ml in 0.1 ml divisions
- Graduated from 1 to 10 ml in 0.5 ml divisions
- 10 to 40 ml in 1 ml divisions also marked at 1000 ml
- Facilitates the determination of the amount of sediment in sewage or industrial waste

Product Code	Approx Total Height mm	Approx Top Diameter mm	Quantity Per Case
2160094	454	110	1

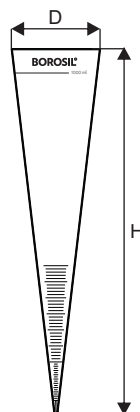

## 2180 - Cones, Imhoff, Sediment, Blunt Tip

- Complies with IS 7232
- The blunt tip increases its ruggedness and cleaning ease
- Ideal for use with heavy sediments where the ability to read small volumes is unimportant
- Facilitates the determination of the amount of sediment in sewage or industrial waste

Product Code	Approx Total Height mm	Approx Top Diameter mm	Quantity Per Case
2180093	439	110	1

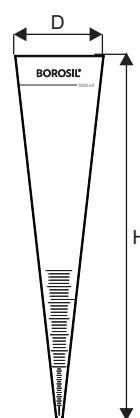

# BOROSIL®

Pioneers in speciality glass



Chromatography Vials & Closures

"for Labs where  
*compliance* matters"



LABQUEST  
Laboratory equipment and tools  
BOROSIL



C1 micro pipettes



BOROSIL  
KLASSPACK  
pharmaceutical packaging



- ISO 9001-2008
- US and Canadian DMF
- Extractable Data
- Glass Ampoules
- Tubular Glass Vials





# Did You Know?

## What does TD and TC on graduated glassware mean?

Some volumetric glassware bears the label "TC 20°C" which stands for "to contain at 20°C." This means that at 20°C, that flask will have precisely the volume listed inside it. If you were to pour out the liquid, you would need to get every drop out of it to have that volume. Alternatively, some volumetric glassware bears the label "TD 20°C" which stands for "to deliver at 20°C." This means that at 20°C, precisely the volume listed will leave it when the contents are allowed to drain out of the vessel. It is not necessary to get every last drop and, in fact, it is inaccurate to blow the last bit out of a volumetric pipet.



# Condensers

A Condenser is designed to facilitate the cooling of hot vapours and liquids. It is structured in the form of a large glass tube, containing a smaller glass tube running through its entire length. Hot fluids pass through this small inner tube.

Typically, the outer glass tube has two hose connections to aid the passing of a coolant (usually tap water or chilled water/anti-freeze mixture). The coolant is introduced through the lower fitting, while the higher fitting serves as the exit point. Entering the coolant at the cooler point is a critical aspect as it helps maintain a smooth and correctly directed thermal gradient. This in turn, maximises efficiency and minimises the risk of thermal shock to adjacent glassware. Multiple Condensers may be connected in a series. Usually, a high flow rate is not essential for maintaining a cooling surface.

Special care should be taken while choosing Condensers keeping in mind their distillation rates, reflux rates and temperature gradients.

Borosil offers you the choice of a wide range of Condensers.



## 2340 - Condensers, Liebig, with Sealed Inner Tube

- Simple design
- The light wall of the inner tube facilitates efficient heat transfer
- Low cooling capacity
- Used for distillate separation

Product Code	Approx Jacket Length mm	Approx Overall Height mm	Interchangeable Joints	Quantity Per Case
2340087	200	350	19 / 15	5
2340090	300	450	19 / 15	5
2340092	400	550	19 / 15	5
2340095	500	650	19 / 15	5

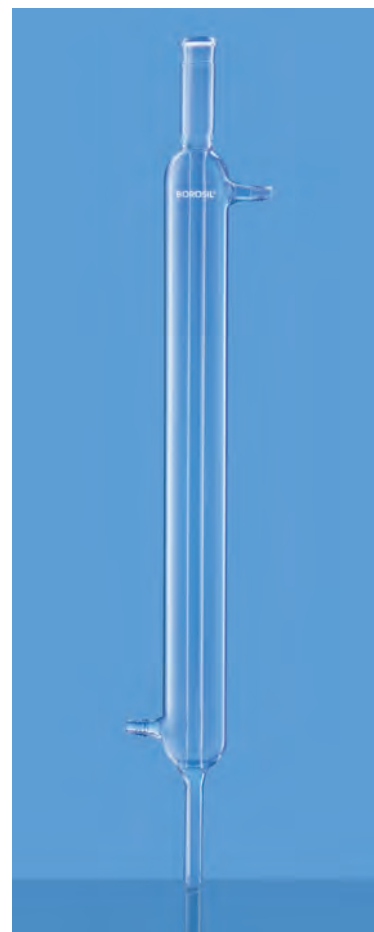
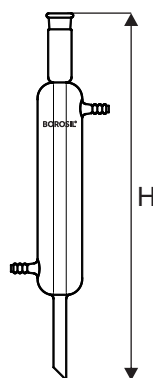

## 2400-Condensers, Liebig, Drip Tip, Interchangeable Inner and Outer Joint

- Simple design
- The light wall of the inner tube facilitates efficient heat transfer
- Low cooling capacity
- Used for distillate separation

Product Code	Approx Jacket Length mm	Approx Overall Height mm	Interchangeable Joints		Quantity Per Case
			Socket	Cone	
2400087	200	350	19 / 26	19 / 26	5
2400090	300	450	24 / 29	24 / 29	5
2400092	400	550	24 / 29	24 / 29	5

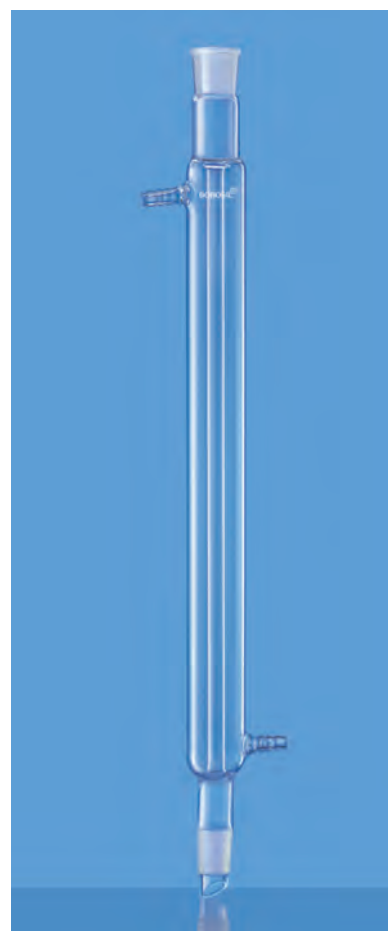
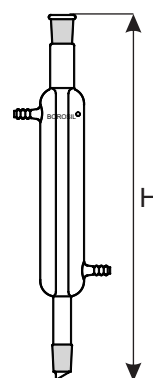

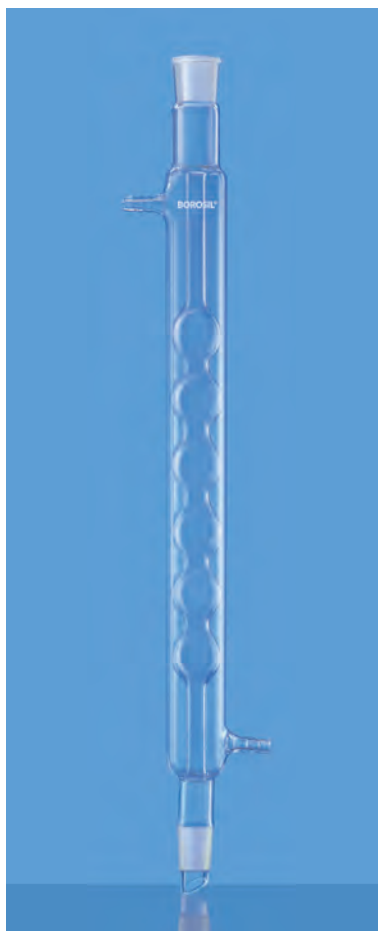

### 2480 - Condensers, Allihn, Drip Tip, Interchangeable Inner and Outer Joint

- Greater surface area than the Liebig Condenser owing to a series of bulbs, resulting in higher cooling capacity
- Ideal for laboratory scale refluxing

Product Code	Approx Jacket Length mm	Approx Overall Height mm	Interchangeable Joints		Quantity Per Case Cone
			Socket	Cone	
2480087	200	330	19 / 26	19 / 26	5
2480090	300	450	24 / 29	24 / 29	5
2480092	400	550	24 / 29	24 / 29	5
2480096	600	750	29 / 32	29 / 32	5

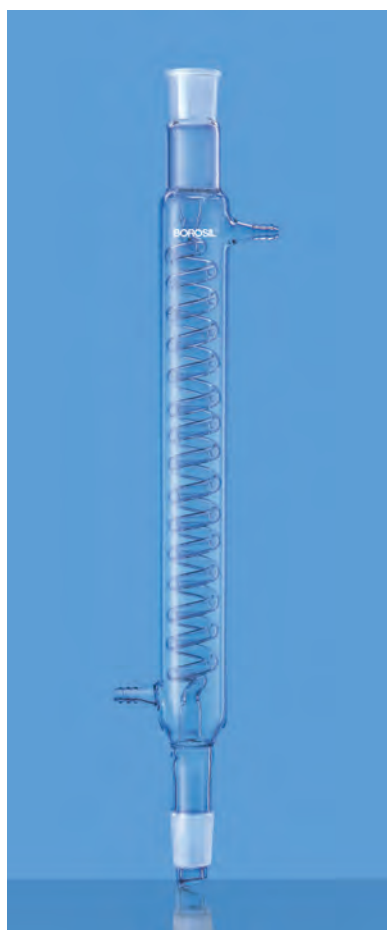
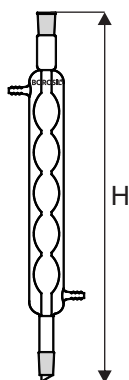

### 2560-Condensers, Graham, Coiled Distillate Type, Drip Tip, Interchangeable Inner and Outer Joint

- The coiled condensation tubes result in greater surface area for cooling
- Designed with top standard taper outer and lower inner drip tip joint

Product Code	Approx Jacket Length mm	Approx Overall Height mm	Interchangeable Joints		Quantity Per Case
			Socket	Cone	
2560090	300	450	24 / 29	24 / 29	5
2560092	400	550	24 / 29	24 / 29	
2560095	500	650	24 / 29	24 / 29	5

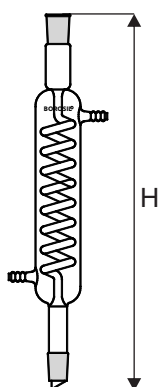

## 2640 - Condensers, Friedrichs, Drip Tip, Interchangeable Inner and Outer Joint

- Specially designed inner spiral tubes ensure a long vapour path
- Offer better heat transfer and anti-flooding capabilities

Product Code	Approx Overall Height mm	Interchangeable Joints		Quantity Per Case
		Socket	Cone	
2640097	350	24 / 29	24 / 29	5

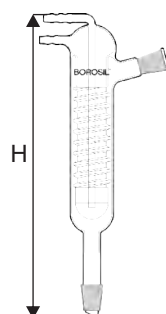

## 2641 - Condensers, Double Surface

Product Code	Length of Height mm	Interchangeable Ground Joint	Quantity Per Case
2641087	200	19 / 26	5
2641187	200	24 / 29	5
2641090	300	19 / 26	5
2641190	300	24 / 29	5

The above condensers are widely used in research labs. A double-surface condenser has a water jacket both on the outside and through the centre of the condensing tube. It is needed where the condensed liquid is very volatile. Hence for distilling ethers, alcohols, esters, aromatics, petroleum products, and essential oils these condensers are widely used.

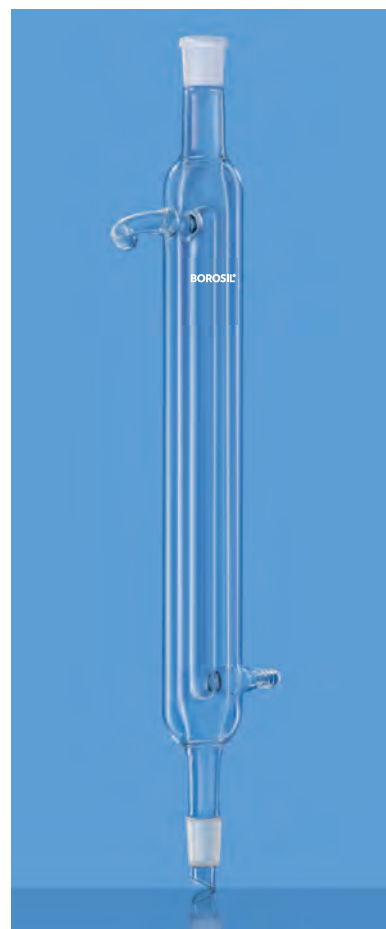
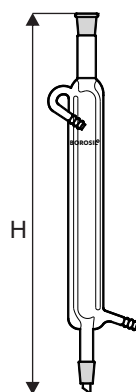

# Cylinders

Measuring cylinders serve simultaneously to receive and measure different amounts of liquids. Made from specially drawn 3.3 Borosilicate glass tubing with durable, easy to read graduations for assured accuracy.

Borosil Brand Cylinders are built to last. We have built strength features into every cylinder. Heavy uniform wall tubing and strong stable hexagonal base contribute to sturdiness. Hexagonal base also prevents them from rolling off a laboratory bench. They are available in capacities from 5 ml to 2000 ml.

For accurate work, Class A certified cylinders are available.

Our range also includes Nessler Colour Comparison and Rain Measure Cylinders.



- Complies with highest quality standards according to IS 878 and EN ISO 4788
- Manufactured From 3.3 Low expansion borosilicate glass with precision bore tubing
- Individually calibrated on automatic calibration machine for precision and high accuracy
- Strict quality control through all steps eradicate possible deviations
- All measuring cylinders are calibrated to contain ( TC, In ) and all tolerances are according to IS / ISO / DIN / ASTM class " A " Standards
- Supplied with individual certificate and can be download from our website
- Specially designed hexagonal base provides sturdiness to the cylinder
- Perfect spout designed assures pouring without any drips
- Graduations and Inscriptions are printed in amber / white enamel
- Cylinders are also available with penny head stopper

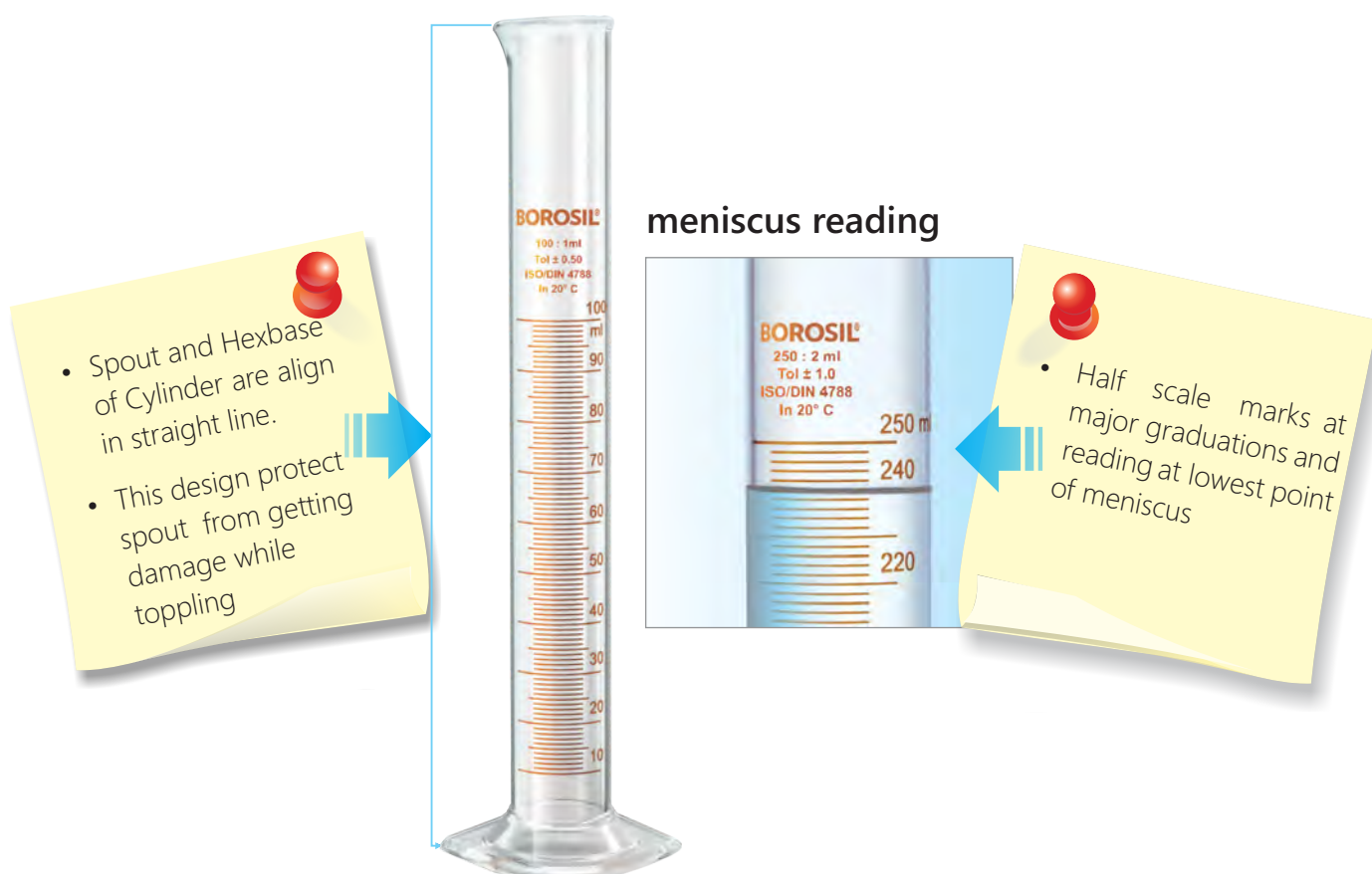

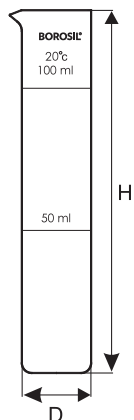

## 2975 - Cylinders, Colour Comparison, Nessler, Flat Bottom, Graduated

- Complies with IS 4161
- Facilitates colour comparison of water samples
- Manufactured from precision bore 3.3 borosilicate tubing selected for freedom from colour or visible defects
- White enamel inscriptions

Product Code	Capacity ml	Approx O.D. x Height mm	Quantity Per Case
2975012	50	25 x 150	20
2975016	100	34 x 180	30

100 ml Cylinder is marked at 50 ml and 100 ml  
50 ml Cylinders is marked at 50 ml



## 2981-Cylinders, Graduated, Single Metric Scale, with Penny Head Interchangeable Stopper with Hexagonal Base, Class A, with Batch Certificate

- Complies with IS 878, EN ISO 4788
- Each cylinder is engraved with a unique serial number, and comes with a Certificate of Calibration traceable to national standards
- Graduations in Amber enamel
- Sturdy hexagonal base prevents roll-over and ensures greater stability
- Solid glass stopper

Product Code	Capacity ml	Graduation Interval ml	Tolerance $\pm$ ml	Stopper Size	Quantity Per Case
2981005A	5	0.1	0.05	10 / 19	5
2981006A	10	0.2	0.10	10 / 19	5
2981009A	25	0.5	0.25	14 / 23	10
2981012A	50	1.0	0.50	14 / 23	10
2981016A	100	1.0	0.50	19 / 26	10
2981021A	250	2.0	1.00	24 / 29	5
2981024A	500	5.0	2.50	24 / 29	5
2981029A	1000	10.0	5.00	34 / 35	4
2981030A	2000	20.0	10.0	34 / 35	4

- Blue enamel inscription can be supplied on request
- Individual calibration certificate can be provided on request

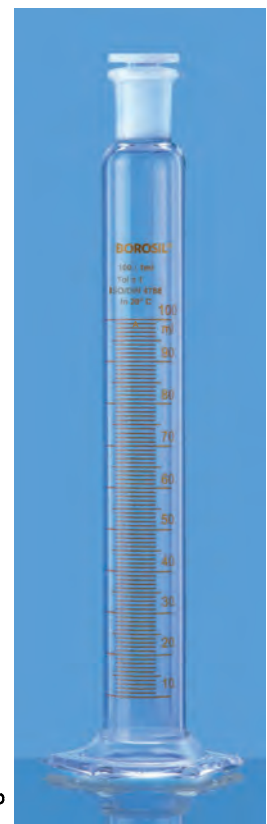
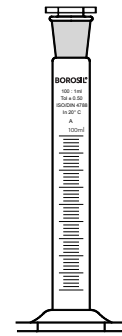

## 2982-Cylinders, Graduated, Single Metric Scale, with Penny Head Interchangeable Stopper with Hexagonal base, Class B

- Complies with IS 878, EN ISO 4788
- Graduations in Amber enamel
- Sturdy hexagonal base prevents roll-over and ensures greater stability
- Solid glass stopper

Product Code	Capacity ml	Graduation Interval ml	Tolerance $\pm$ ml	Stopper Size	Quantity Per Case
2982005D	5	0.1	0.1	10 / 19	5
2982006D	10	0.2	0.2	10 / 19	5
2982009D	25	0.5	0.5	14 / 23	10
2982012D	50	1.0	1.0	14 / 23	10
2982016D	100	1.0	1.0	19 / 26	10
2982021D	250	2.0	2.0	24 / 29	10
2982024D	500	5.0	5.0	24 / 29	5
2982029D	1000	10.0	10.0	34 / 35	4
2982030D	2000	20.0	20.0	34 / 35	4

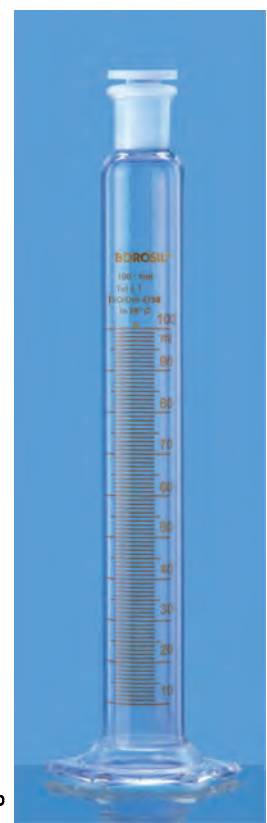
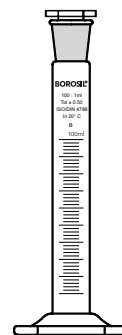

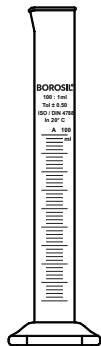
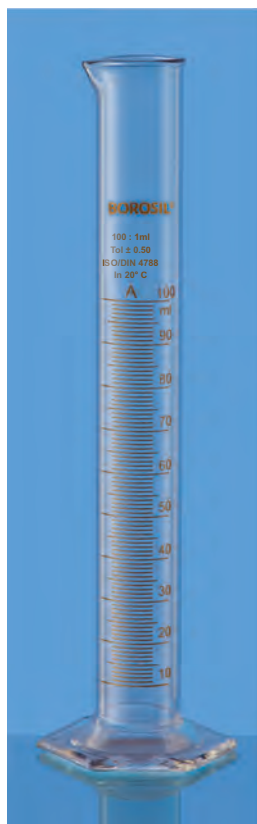

### 3021-Cylinders, Graduated, Single Metric Scale, with Pour Out, with Hexagonal Base, Class A, with Batch Certificate

- Complies with IS 878, EN ISO 4788
- Each cylinder is engraved with a unique serial number, and comes with a Certificate of Calibration traceable to national standards
- Graduations in Amber enamel
- Sturdy hexagonal base prevents roll-over and ensures greater stability

Product Code	Capacity ml	Graduation Interval ml	Tolerance $\pm$ ml	Quantity Per Case
3021005A	5	0.1	0.05	5
3021006A	10	0.2	0.1	5
3021008A	20*	1.0	0.25	10
3021009A	25	0.5	0.25	10
3021012A	50	1.0	0.5	10
3021016A	100	1.0	0.5	10
3021018A	150*	2.0	1.0	5
3021021A	250	2.0	1.0	10
3021024A	500	5.0	2.5	5
3021029A	1000	10.0	5.0	4
3021030A	2000	20.0	10.0	4

\*20 & 150 ml Not covered in any standards.

- Blue enamel inscription can be supplied on request
- Individual calibration certificate can be provided on request

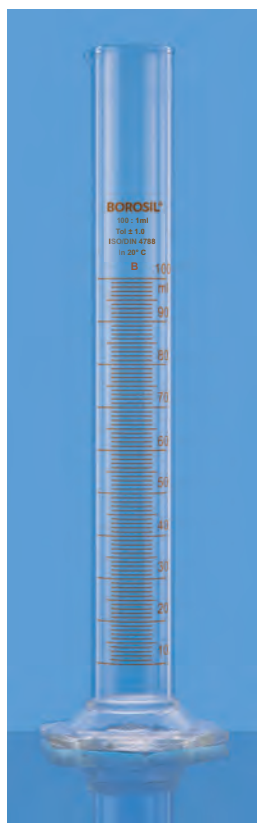

### 3022-Cylinders, Graduated, Single Metric Scale, with Pour out, with Hexagonal Base, Class B

- Complies with IS 878, EN ISO 4788
- Graduations in Amber enamel
- Sturdy hexagonal base prevents roll-over and ensures greater stability

Product Code	Capacity ml	Graduation Interval ml	Tolerance $\pm$ ml	Quantity Per Case
3022005D	5	0.1	0.1	5
3022006D	10	0.2	0.2	5
3022009D	25	0.5	0.5	10
3022012D	50	1.0	1.0	10
3022016D	100	1.0	1.0	10
3022018D	150*	2.0	2.0	5
3022021D	250	2.0	2.0	10
3022024D	500	5.0	5.0	5
3022029D	1000	10.0	10.0	4
3022030D	2000	20.0	20.0	4

\*150 Not covered in any standards.

**2011 - Cylinders Graduated, Single metric scale with pour out with Hexagonal Base, Class A Certificate, ISO 4788, NABL Certified**

Product Code	Capacity ml	Graduation Interval	Tolerance $\pm$ ml	Quantity Per Case
2011005	5	0.1	0.05	5
2011006	10	0.2	0.1	5
2011009	25	0.5	0.25	10
2011012	50	1.0	0.5	10
2011016	100	1.0	0.5	10
2011021	250	2.0	1.0	10
2011024	500	5.0	2.5	5
2011029	1000	10.0	5.0	4
2011030	2000	20.0	10.0	4

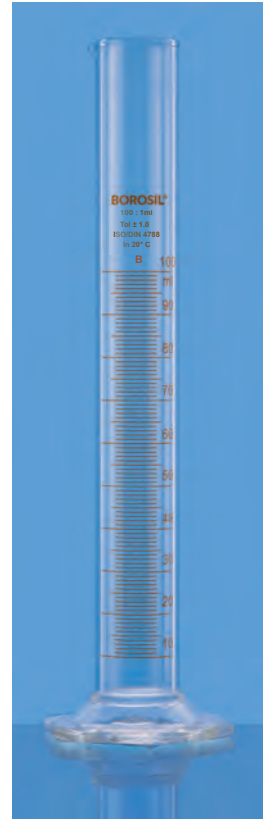
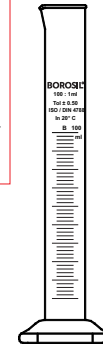

**3024 - Cylinders, Single Metric Scale, with Pour Out, Schelbach type, with Hexagonal Base, Class B**

- Complies with IS 878, EN ISO 4788
- Graduations in Amber enamel
- Sturdy hexagonal base prevents roll-over and ensures greater stability
- Proper visibility to read the meniscus

Product Code	Capacity ml	Graduation Interval ml	Tolerance $\pm$ ml	Quantity Per Case
3024012D		50	1.0	1.05
3024016D		100	1.0	1.05

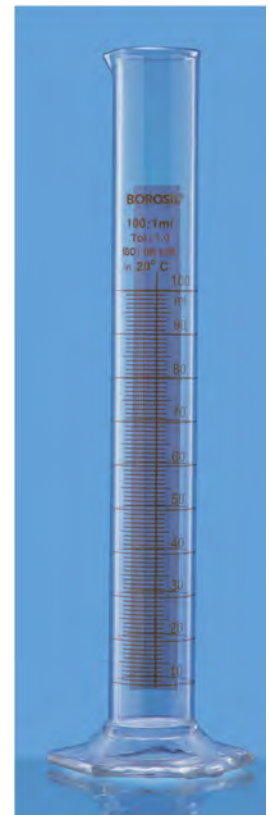
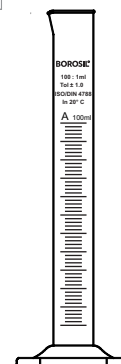

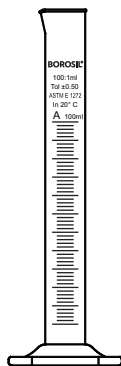
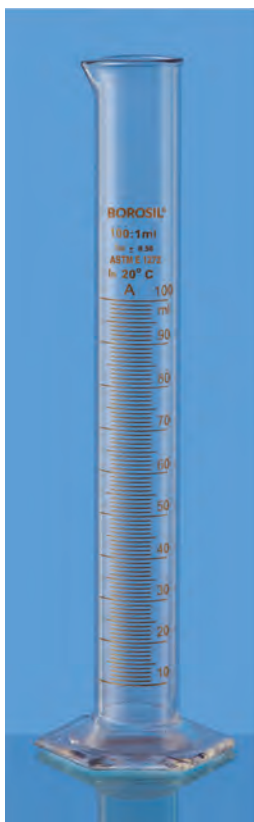

### 3026 - Cylinders, Graduated, Single Metric Scale, with Pour Out, with Hexagonal Base, Accuracy as per ASTM, Class A with Batch Certificate (USP)

- Complies with ASTM E 1272
- Calibrated as per Class A tolerances required by the United States Pharmacopoeia (USP) that are tighter than those of ISO / DIN standards
- Each cylinder is engraved with a unique serial number, and comes with a Certificate of Calibration traceable to national standards
- Graduations in Amber enamel
- Manufactured with chemically resistant 3.3 borosilicate glass
- Sturdy hexagonal base prevents roll-over and ensures greater stability

Product Code	Capacity ml	Graduation Interval ml	Tolerance $\pm$ ml	Quantity Per Case
3026005A	5	0.1	0.05	5
3026006A	10	0.2	0.10	5
3026009A	25	0.5	0.17	5
3026012A	50	1.0	0.25	5
3026016A	100	1.0	0.50	5
3026021A	250	2.0	1.00	5
3026024A	500	5.0	2.00	4
3026029A	1000	10.0	3.00	4
3026030A	2000	20.0	6.00	4

- Blue enamel inscription can be supplied on request
- Individual calibration certificate can be provided on request

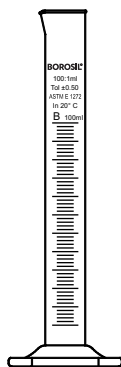

### 3027 - Cylinders, Graduated, Single Metric Scale Pour Out with Hexagonal Base, Accuracy as per ASTM, Class B (USP)

- Complies with ASTM E 1272
- Calibrated as per Class B tolerances required by the United States Pharmacopoeia (USP) that are tighter than those of ISO / DIN standards
- Graduations in Amber enamel
- Manufactured with chemically resistant 3.3 borosilicate glass
- Sturdy hexagonal base prevents roll-over and ensures greater stability

Product Code	Capacity ml	Graduation Interval ml	Tolerance $\pm$ ml	Quantity Per Case
3027005D	5	0.1	0.10	5
3027006D	10	0.2	0.20	5
3027009D	25	0.5	0.34	10
3027012D	50	1	0.50	10
3027016D	100	1	1.00	10
3027021D	250	2	2.00	10
3027024D	500	5	4.00	5
3027029D	1000	10	6.00	4
3027030D	2000	20	12.00	4

- Blue enamel inscription can be supplied on request

**2012 - Cylinders Graduated, Single metric scale with pour out with Hexagonal Base, Class A Certificate, ASTM E 1272, NABL Certified**

Product Code	Capacity ml	Graduation Interval	Tolerance $\pm$ ml	Quantity Per Case
2012005	5	0.1	0.05	5
2012006	10	0.2	0.10	5
2012009	25	0.5	0.17	5
2012012	50	1.0	0.25	5
2012016	100	1.0	0.50	5
2012021	250	2.0	1.00	5
2012024	500	5.0	2.00	4
2012029	1000	10.0	3.00	4
2012030	2000	20.0	6.00	4

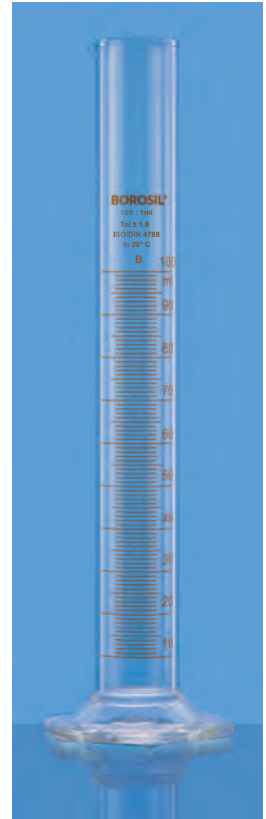
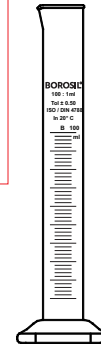

**3032 - Tapped Density Cylinder, As Per USP, Ch. 616**

- Used in tapped density apparatus to measure bulk density of powders

Product Code	Capacity ml	Quantity Per Case Set
3032041	100 & 250	1

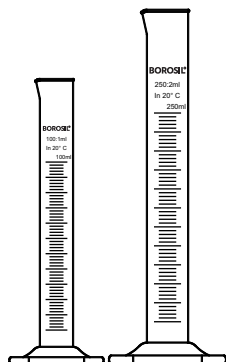
**3033 - Tapped Density Cylinder, As Per USP, Ch. 616**

Product Code	Capacity ml	Quantity Per Case
3033016	100	2

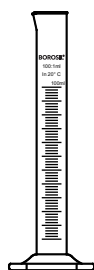
**3034 - Tapped Density Cylinder, As Per USP, Ch. 616**

Product Code	Capacity ml	Quantity Per Case (Set )
3034021	250	2

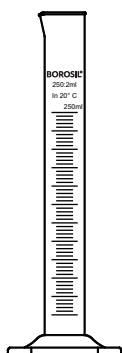

### 3070 - Cylinders, Rain Measure, Metric Scale, Graduated, With Round Base

- Complies with IS 4849
- Manufactures with chemically resistance 3.3 borosilicate glass
- Graduation in white enamel
- The cylinders are graduated to indicate rainfall in mm when used with appropriate rain collector

Product Code	Size mm	Used For Collector Area cm <sup>2</sup>	Graduation Interval mm	Tolerance ± mm	Quantity Per Case
3070096	20	200	0.2	0.05	5
3070098	20	100	0.2	0.10	10



Cylinders

# Dessiccators

**BOROSIL®** brand Desiccators are equipped with bodies and covers that have great strength and utility. The body is designed with a streamlined contour that facilitates easy cleaning of the used desiccant. Any desiccant such as sulphuric acid, phosphoric pentoxide, calcium chloride or silica gel may be used in Borosil brand Desiccators. For your convenience, all Borosil brand Plain Desiccators of the same size have interchangeable covers and bodies. When the ground surface is cleaned and greased, Vacuum type Desiccators hold a vacuum of 500 mm of mercury.

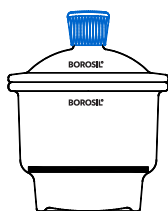

## 3082 - Desiccators, with Cover and Porcelain Plate, Plastic Knob

- Complies with IS 6128
- Robust Desiccator base and cover made of borosilicate glass
- Simple design for drying under atmospheric pressure
- Ground glass flanges
- Plates are positioned on an internal ledge within the base
- Generally used for drying of moist products, and for storage of moisture-sensitive substances

Product Code	Approx ID Ground Flange mm	Quantity Per Case
3082041	100	1
3082042	150	1
3082043	200	1
3082044	250	1
3082045	300	1

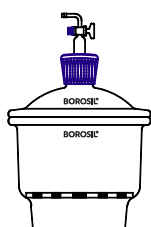

## 3083 - Desiccators, Vacuum, Stopcock with PTFE Spindle, and Porcelain Plate

- Complies with IS 6128
- Designed for use under vacuum
- Sturdy construction of borosilicate glass
- Ground glass flanges
- Plates are positioned on an internal ledge within the base
- Comes with glass stopcock at the top
- Generally used for drying of moist products, and for storage of moisture sensitive substances

Product Code	Approx ID Ground Flange mm	Quantity Per Case
3083041	100	1
3083042	150	1
3083043	200	1
3083044	250	1
3083045	300	1



### 3084 - Desiccators, with Cover and Porcelain Plate, Plastic Knob, Amber

- Complies with IS 6128
- Robust Desiccator base and cover made of borosilicate glass
- Simple design for drying under atmospheric pressure
- Ground glass flanges
- Plates are positioned on an internal ledge within the base
- Generally used for drying of moist products, and for storage of moisture-sensitive & light sensitive substances

Product Code	Approx ID Ground Flange mm	Quantity Per Case
3084041	100	1
3084042	150	1
3084043	200	1
3084044	250	1
3084045	300	1

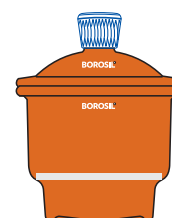

Desiccators

### 3085 - Desiccators, Vacuum, stopcock with PTFE spindle and Porcelain plate, Amber

- Complies with IS 6128
- Designed for use under vacuum
- Sturdy construction of borosilicate glass
- Ground glass flanges
- Plates are positioned on an internal ledge within the base
- Comes with glass stopcock at the top
- Generally used for drying of moist products, and for storage of moisture sensitive & light sensitive substances

Product Code	Approx ID Ground Flange mm	Quantity Per Case
3085041	100	1
3085042	150	1
3085043	200	1
3085044	250	1
3085045	300	1

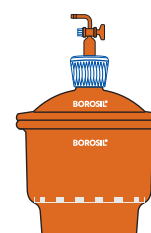

CHEMICAL  
DURABILITY



ACCURACY



for Labs where  
*compliance* matters™



Manufacturers of Laboratory Glassware  
From 3.3 Low Expansion Borosilicate Glass



*Over half a century of trust*

THERMAL  
SHOCK  
RESISTANCE



MECHANICAL  
STRENGTH

Water Distillation  
Purification System



LABQUEST  
BOROSIL®



**BOROSIL®**  
Pioneers in speciality glass

**Borosil Glass Works Ltd.**

**Corporate Office :**

1101, Crescenzo, G-Block, Opp. MCA Club, Bandra Kurla Complex,  
Bandra (E), Mumbai - 400 051, India

**Tel :** +91 22 6740 6300

**Email :** [eximbor@borosil.com](mailto:eximbor@borosil.com)

**Fax :** +91 22 6740 6514

**Website :** [www.borosil.com](http://www.borosil.com)

Did  
You  
Know?

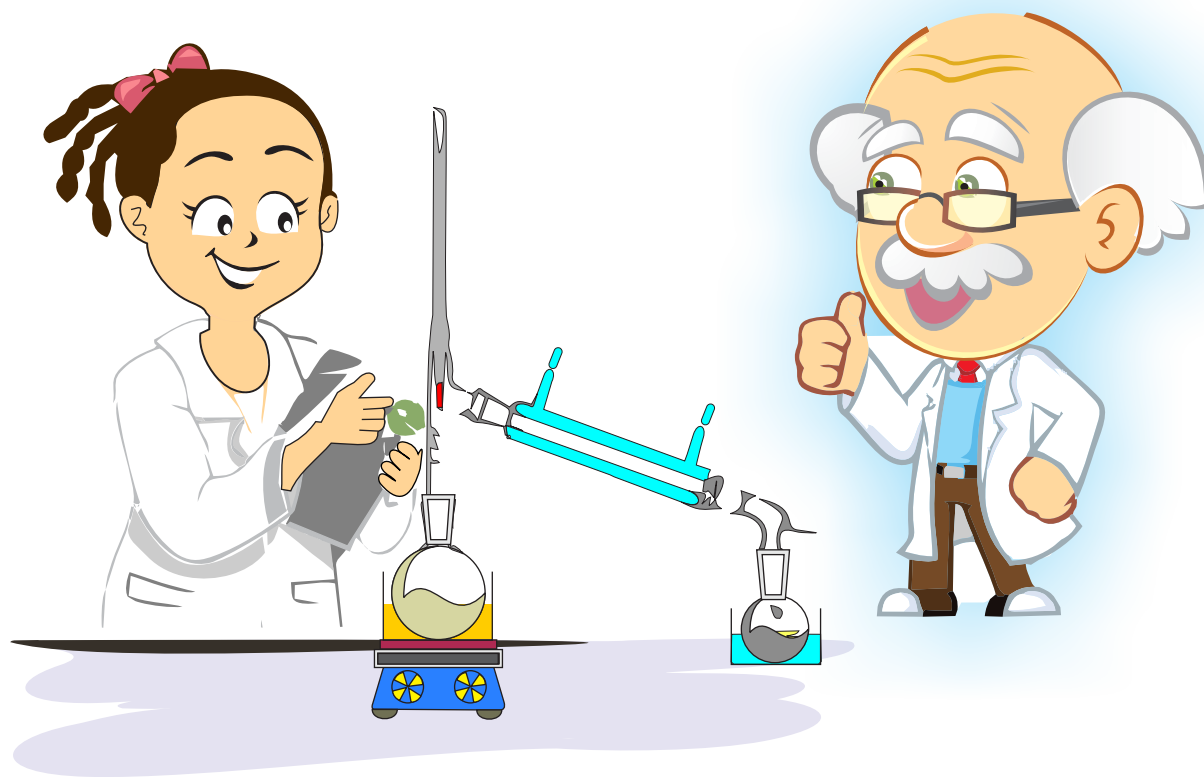

## Distillation Apparatus

“ In 1500, German alchemist Hieronymus Braunschweig published *Liber de arte destillandi* (The Book of the Art of Distillation) the first book solely dedicated to the subject of distillation. ”

**BOROSIL®**

- Dishes
- Distilling Apparatus
- Water Distillation Systems
- Apparatus

# Dishes

**BOROSIL**<sup>®</sup> brand Dishes are designed to fulfil your wide-ranging needs - Crystallizing, Evaporating, Drying, Storing, Petri dishes for culture, assay and micro-biological works. All **BOROSIL**<sup>®</sup> brand Dishes are safe, durable and economical.

**BOROSIL**<sup>®</sup> brand Dishes are inert, can be sterilised and remain clear even after repeated use and washing. With each subsequent use, the cost per Dish decreases.



### 3140 - Dishes, Crystallizing

- Reinforced and fire-polished rims reduce chipping
- Large labelling field for easy marking
- Very high chemical resistance
- High resistance to thermal shocks

Product Code	Approx O.D. x Height mm	Approx Capacity ml	Quantity Per Case
3140077	100 x 50	330	10
3140081	150 x 75	4100	10
3140086	190 x 100	2500	4

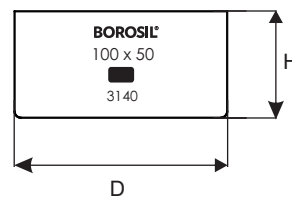

### 3160 - Dishes, Culture, Petri

- Complies with IS 2626
- These Dishes are clear and withstand repeated sterilisation (wet or dry)
- Made of 3.3 borosilicate glass using a special manufacturing process
- Beaded edges impart greater mechanical strength
- Ideal for use in routine work
- Specially formed to ensure even wall thickness and consistent optical performance

Product Code	Approx O.D. x Height mm	Quantity Per Case
3160065	50 x 17	100
3160072	80 x 17	100
3160077	100 x 17	100
3160081	150 x 20	40
3160087	200 x 20	10

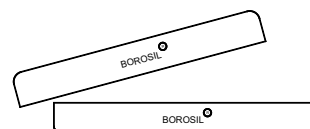

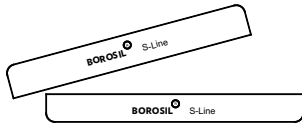

### 3165 - Dishes, Culture Petri, Borosil S-Line

- The inner surface of these Dishes have a very good flatness
- The accuracy of many biological assays depends on the flatness of the inside base of the Petri dish
- Made of soda lime glass ensuring that the inner surface of the top and base are absolutely flat
- These Dishes have high clarity and are free of bubbles
- Ideal for use in routine work

Product Code	Approx O.D. x Height mm	Quantity Per Case
3165065	50 x 12	100
3165072	80 x 15	100
3165075	90 x 17	100
3165077	100 x 15	100
3165A77	100 x 20	100
3165081	150 x 25	40
3165087	200 x 30	10

Petri Dish manufacturing facility, at Gujarat - India.



- Crystal clarity
- Perfect flatness
- Withstands repeated sterilization
- Free from all visual defects
- Free from contamination or fogging



### 3170 - Trays, Drying, Heavy Wall

- The trays withstand hot air or steam sterilization
- Facilitates paper chromatography
- Dimensions are approximate, representing the inside length x width x height in mm

Product Code	Approx Dimension mm	Approx Capacity ml	Quantity Per Case
3170044	320 x 180 x 51	1500	5
3170043	350 x 200 x 58	2400	5
3170042	386 x 217 x 63	3000	5
3170041	404 x 257 x 61	3500	5

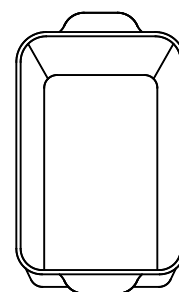

Dishes

### 3180 - Dishes, Evaporating, Flat Bottom, With Pour Out, DIN 12336

- Made of 3.3 borosilicate glass
- Very high chemical resistance
- High resistance to thermal shocks
- Designed with a spout to facilitate clean pouring
- Withstand to repeated sterilisation (Wet or dry)
- Beaded edge give greater mechanical strength
- Ideal for use in routine work

Product Code	Approx O.D. x Height mm	Approx Capacity ml	Quantity Per Case
3180006	40 x 18	10	10
3180007	50 x 25	15	10
3180A11	60 x 30	45	10
3180013	70 x 35	60	10
3180015	80 x 45	90	10
3180A18	95 x 55	170	10
3180A22	115 x 65	320	10
3180025	140 x 80	600	10
3180044	190 x 100	1500	10
3180A30	230 x 130	2500	10
3180072*	80 x 45	165	10
3180078*	105 x 55	290	10
3180081*	150 x 80	855	10
3180087*	200 x 100	1790	8

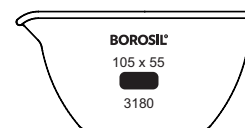

\* Not as per DIN standards

# Distilling Apparatus

Most of the distillation equipment required in an average laboratory can be constructed using standard Borosil components. Distillation assemblies for specific applications are available as complete units, as listed herein.





### 3340 - Distilling Apparatus, Ammonia, with Graham Condenser, Interchangeable Joints

- Ideal for determining nitrogen in organic compounds
- Digestion and distillation stages can be performed in this apparatus
- The inlet tube allows permanganate solution to be introduced after distillation

Product Code	Capacity ml	Quantity Per Case
3340024	500	2 Set

Spares are available on request

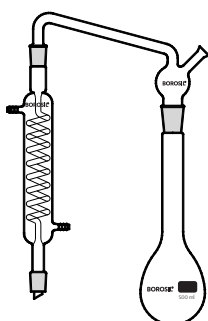

Distilling Apparatus

### 3360 - Distilling Apparatus, with Graham Condenser, Interchangeable Joints, Interchangeable Stopper

- Ideal for batch production of high purity distilled water
- General purpose Batch Distillation Assembly equipped with an interchangeable stoppered neck that facilitates addition
- The Flask has a flat base with a delivery tube on the side

Product Code	Capacity ml	Condenser Jacket mm	Inter-changeable Joint	Quantity Per Case
3360024	500	200	19 / 26	2 Set

Spares are available on request

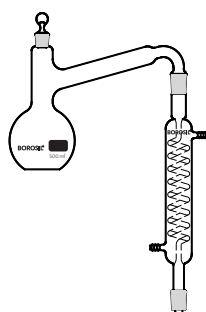



### 3380 - Distilling Apparatus, with Friedrichs Condenser, Interchangeable Joint and Stopper

- Ideal for batch production of high purity distilled water
- General purpose Batch Distillation Assembly equipped with an interchangeable stoppered neck that facilitates addition
- The Flask has a flat base with a delivery tube on the side
- Comes with Friedrich's Spiral Condenser for higher distillation rates

Product Code	Capacity ml	Interchangeable Joint	Quantity Per Case
3380030	2000	24 / 29	1 Set

Spares are available on request

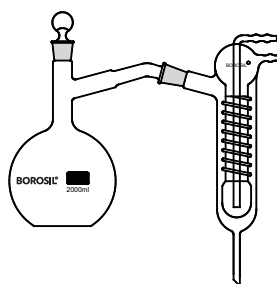

### 3440-Distilling Apparatus, Compact with Friedrichs Condenser, Interchangeable Joint

- A compact distillation assembly with specially designed Friedrich's Condensers
- This Condenser is designed with vapour tubing rising at the top
- A 1000 ml Erlenmeyer Flask is provided with an interchangeable 34/35 joint

Product Code	Capacity ml	Interchangeable Joint	Quantity Per Case
3440029	1000	34 / 35	2 Set

Spares are available on request

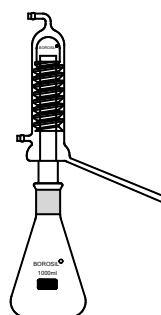

### 3450-Essential Oil Determination Apparatus (Clevenger Apparatus), as per IS 1797, for Oil Heavier Than Water

- This apparatus is ideal for estimation of volatile oil that is heavier than water
- Comes with a 5 ml Receiver with stopcock, an Oil Separator Tube, a condenser and 1000 ml flask

Product Code	Capacity ml	Quantity Per Case
3450029	1000	1 Set
3450030	2000	1 Set
3450033	5000	1 Set
3450038	10000	1 Set
3450040	20000	1 Set

Spares are available on request

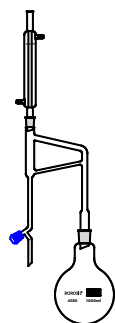

Distilling Apparatus

### 3451-Essential Oil Determination Apparatus (Clevenger Apparatus), for Oil Lighter Than Water

- Ideal for estimation of volatile oil that is lighter than water
- Comes with a 5 ml Receiver with stopcock, an Oil Separator Tube, a condenser and 1000 ml flask

Product Code	Capacity ml	Quantity Per Case
3451029	1000	1 Set
3451030	2000	1 Set
3451033	5000	1 Set
3451038	10000	1 Set
3451040	20000	1 Set

Spares are available on request

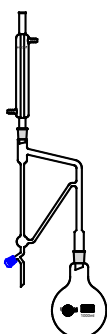



### 3452 - Alcohol Distillation Unit

- Ideal for distilling alcohol in the laboratory to produce the purest grade
- Thorpe's revenue still for purification of ethyl alcohol popularly used in pharmaceutical industries

Product Code	Capacity ml	Quantity Per Case
3452029	1000	1 Set

**Spare are available on request**

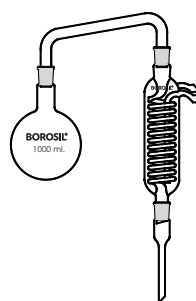

### 3454 - R M Value Apparatus

- Ideal for use in dairy industries
- Facilitates the determination of butter fat, and the analysis of oil, fat and waxes

Product Code	Capacity ml	Quantity Per Case
3454022	300	1
3454A22*	300	1

\* As per IS 548 Part I Standard

**Spare are available on request**

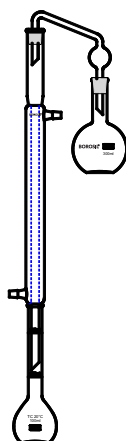

Cat No, 3454A22

### 3602 - Distilling Apparatus, Dean And Stark, Moisture Test, (as per IP Specifications)

- Made of 3.3 borosilicate glass
- Uniform wall distribution of the Flask makes it suitable for heating
- Consists of a graduated 10 ml Receiver with 0.1 intervals

Product Code	Capacity of Receiver ml	Quantity Per Case
3602006	10	2 Set

**Spares are available on request**

Consists of receiver 10 ml graduated with 19 / 26 outer joint and 24 / 29 inner joint, round bottom flask 1000 ml with 24 / 29 outer joint and Liebig condenser 200 mm with 19 / 26 joint. The 10 ml receiver is graduated from 1 ml to 10 ml in 0.1 ml intervals.

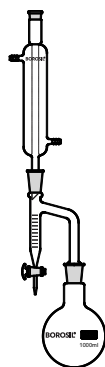

Distilling Apparatus

# Laboratory Water Distillation System

## Eco Water Stills

Distillation removes organics, inorganic impurities, as well as colloidal solids from water.

Borosil glass distillation units continue to be the most effective and economical method of producing pure water for laboratory use.

By contrast, de-ionisers are effective only in removing those substances that are ionised. Moreover, the resins contribute organic impurities to water, resulting in an environment conducive to bacterial growth in course of time.

Borosil distillation units are designed to produce a distillate of consistent purity. The unit consists of horizontal borosilicate boilers, condensers and a quartz heater. All the parts are replaceable.

## Advantages

- Compact and easy to use
- Economical and ideal for educational and general laboratory use
- Powder-coated stand for rust-free operation
- Provision for easy cleaning of the boiler



## Eco MS : All glass single distillation system

- ◆ Single distilled
- ◆ With acid addition funnel & drain stopcock
- ◆ Unique condenser design for maximum output
- ◆ Safety thermostat to prevent over heating in the event of water supply failure



Model	Eco MS
Output per hour	4 Lit / Hr
Typical pH	5.0 - 6.5
Conductivity, $\mu\text{Scm}^{-1}$	3.0 - 4.0
Resistivity, $\text{mOhm-cm}$	0.25 - 0.30
Output Temperature	25 - 35°C
Pyrogen Content*	Pyrogen free
Water supply	1 lit / minute, 3 - 100 psi, (20 - 700kPa)
Electricity supply	220 - 240v, 50 - 60 Hz, Single phase
Power requirement	3 kw
Dimensions (W x D x H)	500 x 150 x 450 mm
Product Code	100336104LG00M

## Smart All quartz double distillation system



- ◆ Compact design
- ◆ Fully automatic operation
- ◆ Microprocessor controller with numeric display
- ◆ In-built trouble shooting analyser
- ◆ Electronic grade-I quartz raw material
- ◆ Built-in timer function
- ◆ Built-in boiler overheat protection
- ◆ Built-in condenser water flow monitoring system
- ◆ Built-in automatic shut off of cooling water, when power fails to saver water.
- ◆ Built-in reservoir controller
- ◆ Audio cum display of failure indication

Model	Smart All Quartz Double Still
Output per hour	2 Lit / Hr
Typical pH	6.9 - 7.0
Conductivity, $\mu\text{Scm}^{-1}$	0.1 - 0.5
Output Temperature	30 - 40°C
Pyrogen Content*	Pyrogen free
Water supply	2 Lit / minute, 3 - 100 psi, (20 - 700 k Pa)
Electricity supply	220 - 240v, 50 - 60 Hz, Single phase
Power requirement	3 kw
Yeast & Mould	Nil
Total Plate Count	Nil
Standard Plate count	Nil
Organic Matter	Nil
KMnO <sub>4</sub> Colour retention	60 Minutes
UV absorbance at 254 mm	0.0007
Product Code	100336502LQ00S



## Cabinet All : glass single or double distillation unit

- ◆ Fully automatic
- ◆ Reservoir level sensor for automatic operation
- ◆ Low temperature distillate
- ◆ Flow switch for boiler safety
- ◆ Manufactured with High quality 3.3 Borosilicate glass
- ◆ Single and double distillation
- ◆ High quality pyrogen free output
- ◆ Easy to clean



Model	Single Distillation	Double Distillation
Output per hour	4 Lit / Hr	4 Lit / Hr
Boiler	3.3 Borosilicate Glass	3.3 Borosilicate Glass
Condenser	3.3 Borosilicate Glass	3.3 Borosilicate Glass
Typical pH	5.0 - 6.0	6.0 - 7.0
Conductivity, $\mu\text{Scm}^{-1}$	1.0 - 2.0	0.8 - 1.0
Output Temperature	30 - 40°C	30 - 40°C
Pyrogen Content*	Pyrogen free	Pyrogen free
Water supply	2 Lit / minute, 3-100 psi, (20-700 kPa)	2 Lit / minute, 3-100 psi, (20-700 kPa)
Electricity supply	220 - 240v, 50 -60 Hz, double phase	220 - 240v, 50 -60 Hz, double phase
Power requirement	3 kw	6 kw
Product Code	100337004LG00C	100337204LG00C

## 3369 - Silicone tubing for distillation unit & laboratory application



\*Heat Resistance Temperature Range: -40°C To +205°C

The technical data given by Borosil must be used as a guide only. Borosil does not guarantee the accuracy of information and is not responsible for its end use.

Silicone tubing is used for laboratory and industrial applications only. It should not be used for implants, human reproductive system and other medical applications.

336900 - 8mm x 12mm is used for 3361-1.5, 3362-1.5, 3363-2.5 series

3369004 - 10mm x 14mm is used for 3361-4l, 3362-4l, 3364-2.5l, 5l, 3365-1.5l, 2.5l, 5l, 3363-5l, 10l.

Product Code	For Cat No.	Size	Quantity per case in mtr
3369001	3369	4mm ID x 7mm OD	10
3369002	3369	6 mm ID x 9 mm OD	10
3369003	3369	8 mm ID x 12 mm OD	10
3369004	3369	10 mm ID x 14 mm OD	10

# BOROSIL®

Pioneers in speciality glass



Borosil laboratory bottles are widely used because of consistency performance & better quality.

#### Retrace Code



For easy traceability



#### Square Bottles



To meet all your storage needs

#### 10 ml



Storage of expensive, sensitive media & reference samples

#### GL 45 Screw Caps



The caps are available in different colours for easy identification

# Kjeldahl

## Infrared Rapid Digestion Unit

with thermal shock resistant quartz digestion tubes

**The Kjeldahl method is the official method for determining nitrogen and protein contents in :**

- Foods (Raw materials and finished products)
- Animal feeds
- Soils, Fertilizers, etc.
- Waste water, sludge, etc.
- Lubricants, fuel oils, etc



Traditionally soils, sediments, sludge's, foods and other materials have been digested using Sulphuric acid in large round-bottomed flasks for Kjeldahl analysis. These were heated on heating mantles and notoriously took up a lot of room in the fume cupboard. In order to maximize the number of digestions in a given space, systems were designed to use tall straight Quartz digestion tubes in racks on a rectangular heating Chamber .

### Kjeldahl Method:

Johan Kjeldahl a Danish Chemist in 1883 while studying the changes of protein content during the transformation of barley into malt process developed the method for determining Nitrogen which then took its name from him. Because of its high degree of precision, reproducibility and versatility, the Kjeldahl method is used today to determine content of Nitrogen and Proteins according to official methods.(AOAC, EPA, DIN, ISO).

Seldom in human history has an invention remained basically unchanged for such a long time as Kjeldahl's method for Nitrogen determination.

More than 90% of Protein containing samples and over 60% of all Nitrogen containing samples can be analyzed by using this basic procedure.

The food industry processes raw material in numerous ways and into many different products, from cheese and bakery products or ice cream production through to uses in meat processing or in the production of ready meals. Hence the overall protein content plays an important role both for the payment of raw material delivered and for determining the value of the product.

- The Digestion Units are compact and well insulated to minimize heat transfer to the surroundings and allow fast, even heating thus giving good working conditions as well as saving energy.
- The Digestion block consists of Quartz Infrared heaters on either sides .
- Energy efficient Quartz Heater and ceramic insulation to retain heat inside the tube.
- Insert rack with handle for easy loading and removal of digestion tubes.
- Exhaust system with glass Manifold and water jet pump (glass filter pump).
- A console to hold the insert rack and exhaust manifold during cooling. This saves time and bench space.
- Digestion tubes 250 ml capacity (**Quartz**).
- PID Controller with auto tuning to obtain precise temperature.



Johan Kjeldahl in his laboratory at Carlsberg Brewery in Copenhagen in the year 1880 (image by courtesy of Carlsberg Archives, Copenhagen)

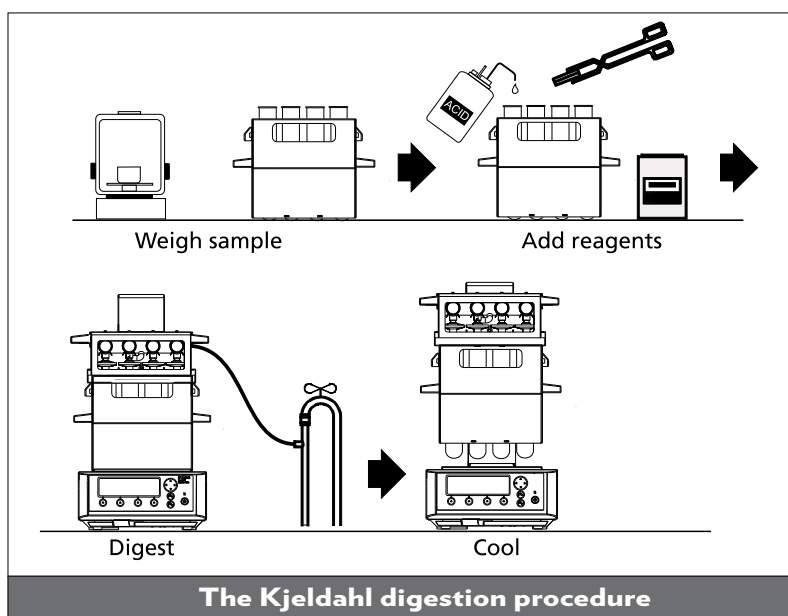

## Temperature indicator/ Controller

Most digestions require only the control of a single temperature and time for example 420°C for 60 minutes. In such a case PID controller with auto tuning is used. When Quartz digestion tubes are used PID controllers with auto tuning serves the purpose.

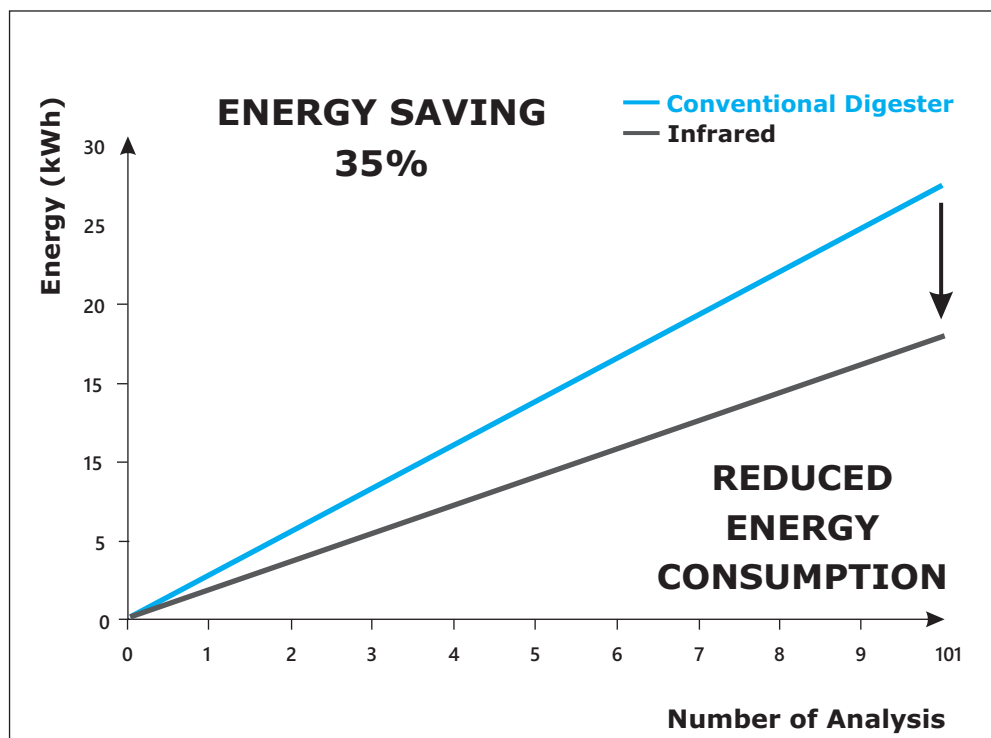

### Apparatus

Product Code	Description
100KID000006	Borosil Kjeldahl Infrared Digestion Unit 6 x 250 ml
100KID000246	Borosil Kjeldahl Infrared Digestion Unit Unit 4 x 500 ml

### Spares

Product	Description
100KIDSQT250	Quartz Digestion Tube 250 ml
100KIDSGM006	Glass Manifold
100KIDSGP006	Glass Filter Pump for 6 Tube Kjekdhal Infrared Digestion Unit
100KIDSAT050	Acid Resistant Tubing 5 mtr/ pack

## A comparison of acid consumption between a classical Kjeldahl system and Infrared digester system.

	Infrared Digester	Classical Kjeldahl
Acid volume used	12-15 ml	25 ml
Loss by evaporation	1.2 ml	7.2 ml
Consumption by 1 g sample	3.6 – 7 ml	3.6 – 7 ml
Consumption by reagents	2.1 ml	4.2 ml
Remaining in digestion tube	1.7 – 5.1 ml	6.6 – 10.0 ml
Alkali volume used	40 ml	100 ml

### The table shows 3 major advantages:

- Acid loss by evaporation is minimized.
- Volume of NaOH that needs to be added during distillation is reduced
- Exact temperature controller can be achieved.

**Quartz Digestion tubes** : Quartz Digestion tubes are excellent for use in Kjeldahl analysis. Unlike borosilicate glass, Quartz can withstand sudden heating and cooling. Quartz tubes can withstand temperatures up to 1000°C and hence boiling of Sulfuric acid at 420°C can be easily done without the fear of breakage.

**Quartz** is better resistant to sulfuric acid attack at elevated temperature than borosilicate glass.

### Infrared digestion compared to block digestion

Samples are heated from underneath, therefore higher requirements for users to prevent boiling delays.

Particularly uniform heating of the samples using side heaters, therefore no zones with different temperatures. Hardly any boiling delays.

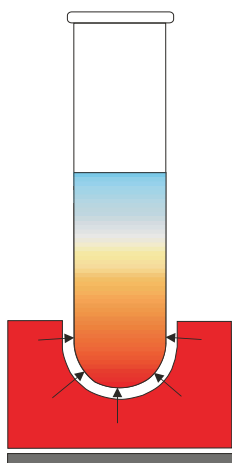

Aluminum block heater

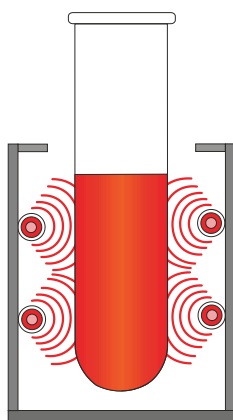

Infrared quartz heater

### Specifications

<b>Model Number</b>	<b>100UID000006</b>
Number of Positions	6 x 250ml
Temperature Range	Ambient to 450° C
Stability & Precision of Heating Chamber	± 1°C
Exhaust manifold	Yes
Sample Rack	Yes
Heating Chamber unit	Completely Stainless Steel
Digestion Tubes	Quartz
Electrical Requirement	230v 50 Hz 1.5 kw

### Spares

Cat. No.	Spare Part
33KIDSQT250	Quartz Digestion Tube 250 ml
33KIDSGM006	Glass Manifold
33KIDSGP006	Glass Filter Pump
33KIDSAT050	Acid resistant Tubing 5mtr /pack

# Kjeldahl

## Distillation Unit

The Kjeldahl distillation unit is used to perform nitrogen analysis and protein determination by Kjeldahl method in food, feed, environmental and chemical industries after digested the sample accurately.



### Operations :

- Check the distilled water level in the steam generator (11)
- Start the cooling water circulation in the condenser (3)
- Dilute the digested sample with distilled water (10-20 ml) and load it into the inner glass tube (8) through the dropping funnel (1)
- Take 25 ml of boric acid solution with indicator in 250 ml conical flask and place it at the receiver end (7)
- Take 40 ml on 40% alkali and keep it ready in the dropping funnel (1) with stop cock closed.
- Check to as certain that all the rubber tubing is tightly fitted.
- Now start the steam generator by switching ON the heater
- The steam generator will now generates steam which passes through the outer jacket tube (9) and then bubble into the inner tube (8) which holds the sample.
- When the steam bubbles vigorously with the digested sample add 40 ml of alkali " immediately" and close the stopcock.
- Now the digested sample in the inner tube (8) turns dark brown.
- Continue the steam distillation until liquid ammonia collects in the boric acid solution. There will be a colour change based on the indicator used. Usually it will be red to green. Collect 100-120ml distillate in the conical flask.
- Switch off the heater and then remove the conical flask and titrate the solution using burette.



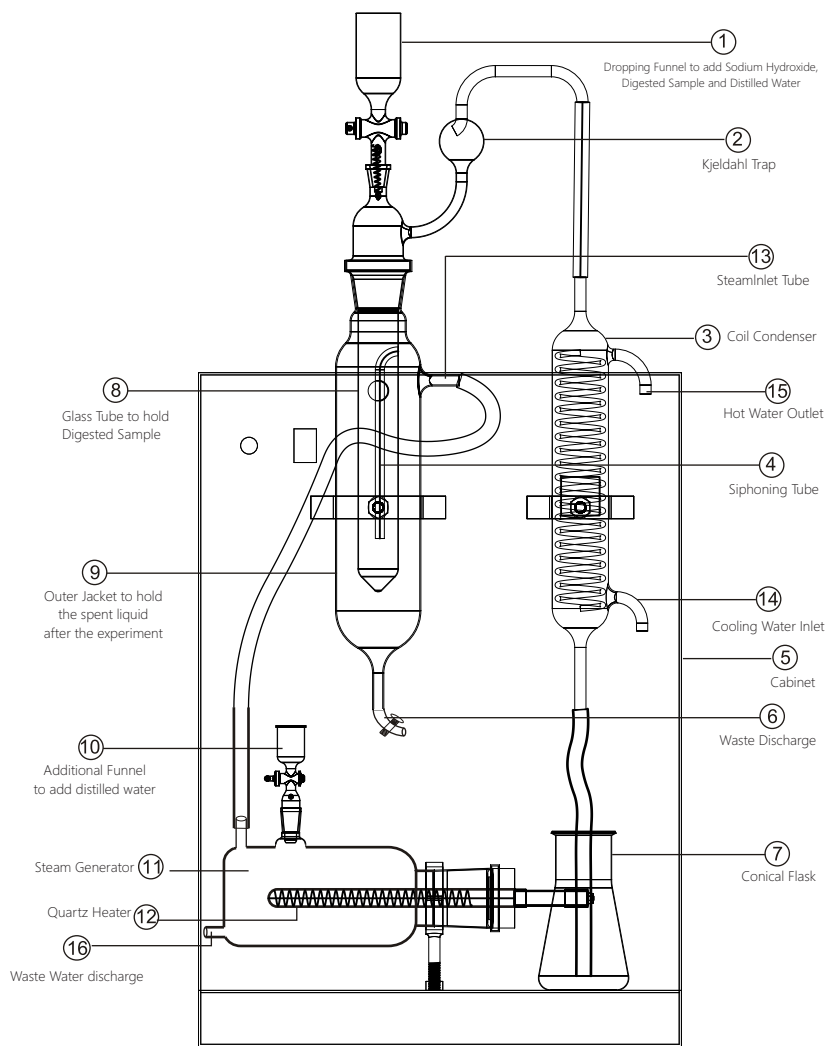

- Now stop the cooling water circulation in the condenser
- Once the heater is switched off, the digested sample automatically gets siphoned into the outer jacket (9) through the siphoning tube (8)
- Add distilled water once or twice to rinse and remove the spent reagent which might be present in the inner tube.
- The spent reagents which gets collected in the outer jacket tube (9) can later be removed by open the pinch-cock and the next experiment can be started. Normally it takes 5 to 7 minutes for distillation of one sample.

### Apparatus

Product Code	Description
100KDU000000	Kjeldahl Distillation Unit
100KDU000S00	Kjeldahl Distillation Unit for Soil Analysis

### Spares

Product Code	Description
100KDUSCF000	Dropping funnel for Kjeldahl Distillation Unit
100KDUSGC00	Coil Condenser for Kjeldahl Distillation Unit
100KDUSGV00	Glass vessel to hold digested sample with trap
100KDUSGJ000	Outer Jacket for spent liquid
100KDUSGY00	Funnel to add distilled water
100KDUSGG00	Steam Generator ( Boiler Only)
100KDUSQH00	Quartz Heater for Kjeldahl



# COD Digestion Unit

The Kjeldahl distillation unit is used to perform nitrogen analysis and protein determination by Kjeldahl method in food, feed, environmental and chemical industries after digested the sample accurately.

The COD Digestion Unit is used for determination of Chemical Oxygen Demand in effluents.

The unit consists of:

- 1) Aluminium block heating unit with provision to keep 8 or 15 samples at a time in 40 mm diameter reaction vessels.
- 2) Air Condensers
- 3) Digital PID temperature indicator cum controller with built in timer for temperatures up to 250°C
- 4) Insert rack to hold the digestion tube with Air Condenser.

## MODEL

1. 8 Samples COD System
2. 15 Samples COD System

## SPARES

1. COD digestion vessel in Borosilicate glass
2. Air Condenser in Borosilicate glass

Product	Description
100COD000008	8 Test COD Digestion Apparatus
100COD000015	15 Test COD Digestion Apparatus
100CODSGT250	COD digestion tubes 250 ml, 5pc / pack
100CODSAC000	COD Air Condenser, 5pc / pack

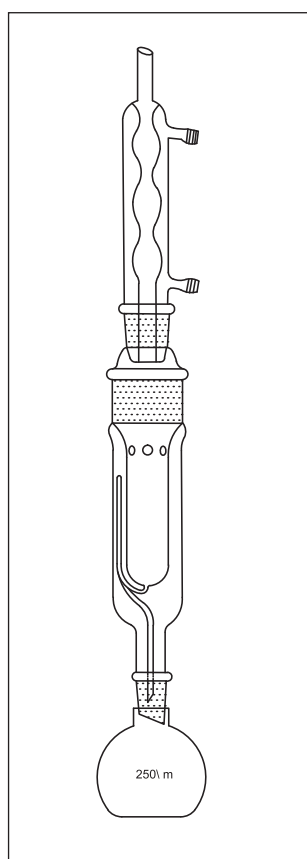

# Soxhlet Hot Extraction

The new jacketed design protects the siphon from breakage and permits the extraction at the boiling point of the solvent. During extraction process the inner cup is enveloped in ascending solvent vapors.

The hot extraction process reduces time considerably. Compared with condensed solvent in the classical soxhlet method where the solvent temperature is below the boiling point, this method is faster because analytes are more soluble in hot vapor than in cold to warm solvent.

It not only reduces time of extraction, but also reduces power and is very easy in handling

Product	Description
100JHE000000	Jacketed Hot Extraction Unit with 250ml flat bottom flask
100JHESGE100	Spare Extractor 100ml

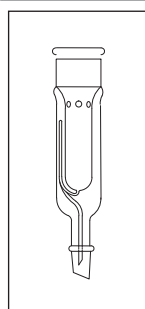

Extractor 100ml

Did  
You  
Know?



## Who created the Erlenmeyer flask?

The Erlenmeyer flask was created by Emil Erlenmeyer in the 1860s to help scientists have a better way of mixing, pouring and storing chemicals.

- Mansingh Survismeter & Viscometer
- Extraction Apparatus
- Flasks
- Filtration Assembly

**BOROSIL®**

## Mansingh Survismeter

(Singapore Govt. Patent No. 126089)

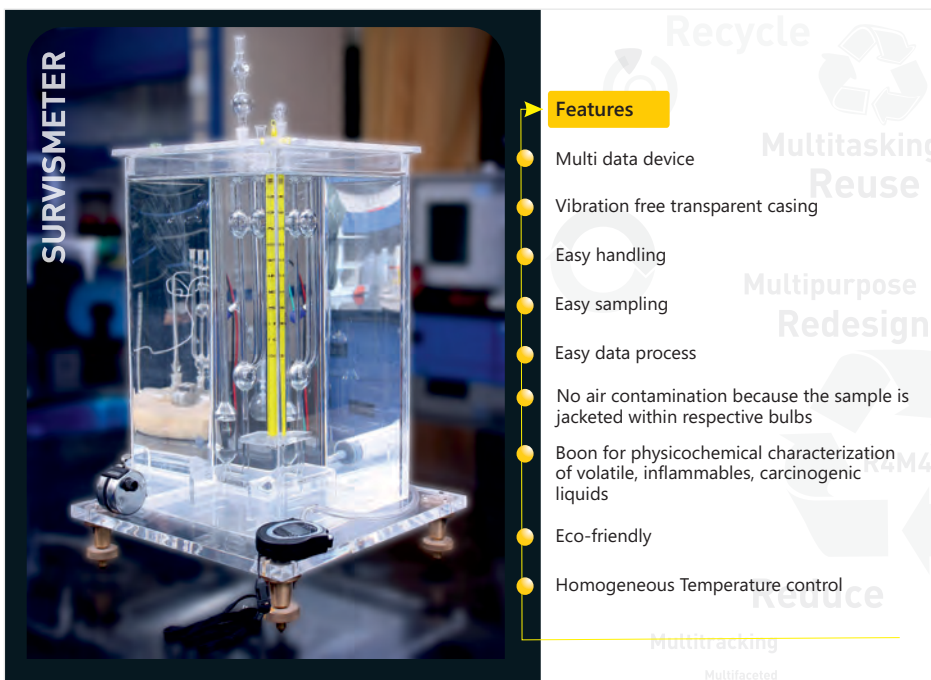

Cat. No.	Description	Quantity Per Case
3453	Borosil Mansingh Survismeter For Measurement of surface Tension and Viscosity	1 Set

For centuries, surface tension ( $\gamma$ ) and viscosity ( $\eta$ ) data have been measured using separate instruments, resulting in wastage of time and materials. Made of Borosil Glass material, Borosil Mansingh Survismeter has been designed to measure surface tension, interfacial tension, wetting coefficient, viscosity and friccohesity data to rationalise frictional and cohesive forces, respectively. Friccohesity focuses on a complete friccochemistry of giants and supramolecular mixtures. Borosil Mansingh Survismeter is a state-of-the-art apparatus for measurement of surface tension ( $\pm 0.01$  mN/m), interfacial tension

( $\pm 0.01$  mN/m), viscosity ( $\pm 10^{-4}$  mPa.S), wetting coefficient ( $\pm 0.01$  mPa.cm<sup>2</sup>) friccohesity ( $\pm 10^{-6}$  s/cm) and related physicochemical parameters generated from intramolecular electrostatical shifts.

Borosil Mansingh Survismeter, being a green science TSAD (Trusted Sustainable Analytical Device), measures the above mentioned PCI (PhysicoChemical Indicators), while simultaneously saving 98% of experimental resources, infrastructure and skilled manpower, for interacting and reacting molecular materials.

A breakthrough in laboratory instruments, Borosil Mansingh Survismeter has wider analytical potential for quality control and formulations in material applied sciences. It has unique essential facilities and cutting edge features based on 'On & Off' or '0 & 1' circuitry functional loops.

Fundamentally, Borosil Mansingh Survismeter measures surface tension, interfacial tension, wetting coefficient, viscosity and friccohesity simultaneously of aqueous, non-aqueous, aprotic dipolar, polar, protic polar and non-polar solvents and mixtures within wider ranges.

- The absolute and relative parameters are measured with 95.5% CV (Confidence Variance).
- It works on the theory of R4M4 [Reduce Reuse Recycle Redesign - Multipurpose Multidimensional Multifaceted Multitracking of materials and methods with highly précised and accurate experimental results, along with 100% inhibition of polluting discharges in experimental determinations.

- The parameters measured with Borosil Mansingh Survismeter are highly significant and reliable for quality analysis of pharmaceuticals, biochemicals, cosmetics, agrochemicals, food and beverages, petroleum and oils, polymer and proteins, sol gels, soaps and detergents, inks, colloids, emulsion technology, pesticides, agrochemicals, insecticides, cutting oils, lubricating, viscous, moderately viscous and highly viscous materials.
- It is especially useful for characterising liquid mixtures of biopolymers, supramolecular chemistry, biotechnological processes and molecular interaction engineering of biomolecular devices, tracking interaction molecular forces, water binding capacities and structural changes during processes.
- It explains the features of Intramolecular Multiple Force Theory (IMMFT) applicable to giant supramolecules, dendrimers and biocomplexes used in several adverse temperature and pressure conditions.
- Borosil Mansingh Survismeter is an asset in case of volatile, moderately and highly volatile liquids and mixtures, volatile organic compounds, flammable liquids and carcinogenic materials as the samples are completely jacketed especially for surface tension, interfacial tension and wetting coefficient determinations.

#### Merits of Borosil Mansingh Survismeter :

- Fast and multipurpose technology
- Eco-friendly and user-friendly
- Reduces fabrication expenditure
- Reduces the need for glass blowing gases, oxygen gas, LPG and manpower
- Reduces emission of heat into the environment
- Ensures safety during transport and maintenance
- Reduces chemicals and solvents greatly
- Contributes to the promotion of green chemistry
- Innovative for youngsters
- No wastage of the sample
- Requires a smaller sample
- Less time required for analysis
- Requires no basic maintenance
- Non-destructive
- Reduces cleaning reagents
- Reduces the number of operational steps in measurement
- Minimises the infrastructure as compared to individual devices

#### Industrial Applications

Industries such as cosmetics, soaps and detergents, petroleum and oils, pesticides, beverages, textiles, paints, polymers and textiles, paper pulp, ink and dyes, medicines and drugs, food and mineral water, and coolants and lubricants will directly benefit from the use of Borosil Mansingh Survismeter.

## Viscometer

### 3500 - Viscometer College Pattern, Oswal 80 - 100 Seconds, Uncertified

Product Code	Size	Nominal Constant	Viscosity Range (CS)	Quantity Per Case
3500	○	0.001	0.3 - 3	10

- Supplied without Certificate

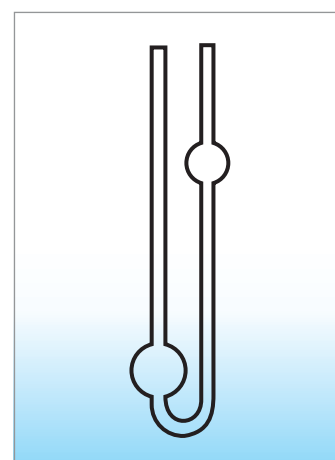

# Extractors

Liquid Solid Extraction involves the elution of a solid sample with pure solvent vapour. The sample is held in the Extractor body either directly or in a thimble. The siphoning type of Soxhlet Extractor finds the widest application in laboratory work. Borosil Soxhlet Extraction Apparatus is available in six sizes. The component parts of the apparatus are provided with interchangeable joints for greater flexibility.



## 3740 - Extractors, Soxhlet, Interchangeable Joint

- Complies with IS 10640
- Made of borosilicate glass
- Designed with a bulb in the siphon tube near the top, to aid the siphoning action
- The vapour tube also protects the siphon tube from accidental damage

Product Code	Capacity ml	Interchangeable Joints		Quantity Per Case
		Socket	Cone	
3740013	60	34 / 35	24 / 29	5
3740016	100	40 / 38	24 / 29	5
3740020	200	50 / 42	24 / 29	5

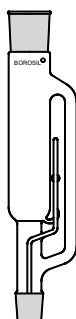

## 3741 - Condensers, Allihn Only For Extraction Apparatus

- Made of borosilicate glass
- Greater surface area than the Liebig Condenser owing to a series of bulbs, resulting in higher cooling capacity
- Ideal for laboratory scale refluxing

Product Code	Capacity ml	Interchangeable Joints	Quantity Per Case
		Cone	
3741013	Small	34 / 35	5
3741016	Medium	40 / 38	5
3741020	Large	50 / 42	5

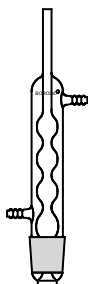

## 3840 - Extraction Apparatus Soxhlet Complete With Allihn Condenser, Interchangeable Joint

- Complies with IS 10640
- Used for separation of the extract from the liquid or solid
- Greater surface area than the Liebig Condenser owing to a series of bulbs, resulting in higher cooling capacity
- This method enables effective separation, with relatively small quantities of solvent
- Ideal for laboratory scale refluxing

Product Code	Capacity ml	Flask Size ml	Quantity Per Case Set
3840013	60	150	1
3840016	100	250	1
3840020	200	500	1
3840024	500*	2000	1
3840029	1000*	3000	1
3840030	2000*	5000	1

Spares are available on request

For flask refer Cat No. 4100

\* Extractor Supplied are with double surface condenser for higher cooling capacity

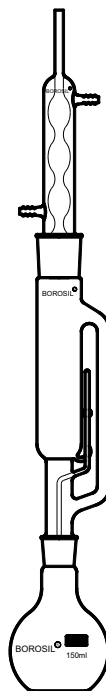

# Flasks

All laboratories need Flasks of different types. **Borosil** offers a wide range of Flasks for a variety of applications such as boiling, culture, distilling, Erlenmeyer, Filtering, Iodine and Kjeldahl. Choose one to suit your needs.

**BOROSIL**<sup>®</sup> brand Flasks are designed to deliver the best combination of thermal shock resistance, physical strength and resistance to chemical attack. They are made so as to withstand the demands of the modern laboratory. Flasks with interchangeable joints are particularly suitable for all glass apparatus assemblies.

**Borosil** offers the interchangeable joints most commonly specified for a particular capacity. Tube Adaptors Category Nos. 8800 and 8820 can be used to connect the Flask with a particular size joint to any other apparatus having a different size joint.





## 4060 - Flasks, Boiling, Flat Bottom, ISO 1773

- Uniform wall thickness distribution makes these Flasks ideal for heating
- All sizes have a durable matt-finished enamelled area for marking

Product Code	Capacity ml	Approx O.D. x Height mm	Approx Neck O.D. mm	Quantity Per Case
4060009D*	25**	42 x 90	20	50
4060012D	50	51 x 90	26	50
4060016D	100	64 x 105	26	80
4060018D	150**	75 x 132	28	10
4060021D	250	85 x 138	34	80
4060022D	*300**	88 x 160	24	20
4060024D	500	105 x 163	34	40
4060029D	1000	131 x 190	42	20
4060030D*	2000	166 x 250	42	2
4060031D*	3000**	185 x 300	50	4
4060032D	4000	207 x 250	50	4
4060033D*	5000**	223 x 290	50	2
4060034D	6000	237 x 315	65	1
4060038D	10000	280 x 360	65	1
4060040D*	20000**	350 x 495	75	1

\*\* Not covered in standards

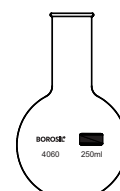

Flasks

## 4061 - Flasks, Boiling, Flat Bottom, ISO 24450, Wide Neck

Product Code	Capacity ml	Approx O.D. x Height mm	Approx Neck O.D. mm	Quantity Per Case
4061012D	50	51 x 90	34	50
4061016D	100	64 x 105	34	80
4061021D	250	85 x 138	50	80
4061024D	500	105 x 163	50	40
4061029D	1000	131 x 190	50	20
4061030D	2000	166 x 230	50	2

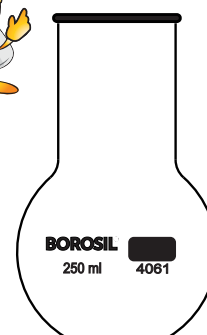



### 4100 - Flasks, Boiling, Flat Bottom, Short Neck, Interchangeable Joint, ISO 4797

Product Code	Capacity ml	Interchangeable Joint	Approx O.D. x Height mm	Quantity Per Case
4100012D	50	29 / 32	51 x 85	5
4100B16D	100	19 / 26	64 x 103	5
4100C16D	100	24 / 29	64 X 103	5
4100D16D	100	29 / 32	64 X 103	5
4100C21D	250*	24 / 29	85 X 130	5
4100D21D	250	29 / 32	85 X 130	5
4100C24D	500*	24 / 29	105 X 160	5
4100D24D	500	29 / 32	105 X 160	5
4100C29D	1000*	24 / 29	131 X 187	2
4100D30D	2000	29 / 32	166 x 230	2

\*\* Not covered in standards

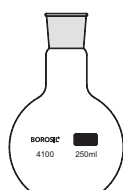

### 4260 - Flasks, Boiling, Round Bottom, ISO 1773

- Uniform wall thickness distribution makes these Flasks ideal for heating
- All sizes have a durable matt-finished enamelled area for marking

Product Code	Capacity ml	Approx O.D. x Height mm	Approx Neck O.D. mm	Quantity Per Case
4260009D*	25**	42 x 90	20	50
4260012D	50	51 x 95	26	70
4260016D	100	64 X 110	26	50
4260021D	250	85 x 144	34	40
4260024D	500*	105 x 168	34	20
4260029D	1000	131 x 200	42	2
4260030D	2000	166 x 260	42	2
4260031D*	3000**	185 x 260	50	2
4260032D	4000	207 x 290	52	2
4260033D*	5000**	223 x 305	50	2
4260034D*	6000**	236 x 355	51	1
4260038D	10000	279 x 380	65	1
4260040D	20000**	345 x 515	76	1

\*\* Not covered in standards



## 4261 - Flasks, Boiling, Flat Bottom, Wide Neck, ISO 24450

- Uniform wall thickness distribution makes these Flasks ideal for heating
- All sizes have a durable matt-finished enamelled area for marking

Product Code	Capacity ml	Approx O.D. x Height mm	Approx Neck O.D. mm	Quantity Per Case
4261012	50	51 x 105	34	70
4261016	100	64 x 110	35	50
4261021	250	85 x 143	51	40
4261024	500	105 x 168	50	20
4261029	1000	131 x 200	50	2
4261030	2000	165 x 240	76	2
4261031	3000**	185 x 260	65	2
4261033	5000**	223 x 310	65	2
4261034	6000	236 x 330	89	1
4261038	10000	279 x 420	89	1
4261040	20000	345 x 520	89	1

\*\* Not covered in standards



## 4265-E-Flask Without Side Cut For Dissolution Apparatus as per USP, with Certificate

- Vessels confirms to all requirements of USP Ch. 711
- Smooth hemispherical base with no flaws or defects, straight sides and a flat flange
- Graduated in intervals of 50ml
- Ideal for determining the dissolution characteristics of drugs in capsules and tablets

Product Code	Capacity ml	Approx O.D. x Height mm	Quantity Per Case
4265029	1000	131 x 173	6



Flasks

## 4266-L-Flask With Side Cut For Dissolution Apparatus, as per USP with Certificate

- These vessels conform to all the requirements of USP Ch. 711
- Smooth hemispherical base with no flaws or defects, straight sides and a flat flange
- Two side-cuts at the flange
- Graduated in intervals of 50ml
- Ideal for determining the dissolution characteristics of drugs in capsules and tablets

Product Code	Capacity ml	Approx O.D. x Height mm	Quantity Per Case
4266029	1000	124 x 173	6

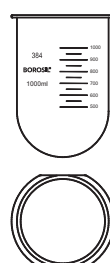



### 4267-E-Flask For Dissolution Apparatus as per USP, Amber, with Certificate

- These vessels conform to all the requirements of USP Ch. 711
- Smooth hemispherical base with no flaws or defects, straight sides and a flat flange
- Graduated in intervals of 50 ml
- Ideal for determining the dissolution characteristics of drugs in capsules and tablets
- Coloured in Amber to protect light-sensitive material
- The Amber colour is applied only to the external surface to prevent contamination with the testing material

Product Code	Capacity ml	Approx O.D. x Height mm	Quantity Per Case
4267029	1000	131 x 173	6

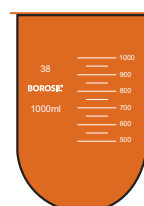

### 4268-L-Flask With Side Cut For Dissolution Apparatus as per USP, Amber, With Certificate

- These vessels conform to all the requirements of USP Ch. 711
- Smooth hemispherical base with no flaws or defects, straight sides and a flat flange
- Two side-cuts at the range
- Graduated in intervals of 50 ml
- Ideal for determining the dissolution characteristics of drugs in capsules and tablets
- Coloured in Amber to protect light-sensitive material
- The Amber colour is applied only to the external surface to prevent contamination with the testing material

Product Code	Capacity ml	Approx O.D. x Height mm	Quantity Per Case
4268029	1000	124 x 173	6

## 4270-D-Flasks for Dissolution Apparatus without side cut, as per USP with Certificate

- Vessels confirms to all requirements of USP Ch. 711
- Smooth hemispherical base with no flaws or defects, straight sides and a flat flange
- Graduated in intervals of 50ml
- Ideal for determining the dissolution characteristics of drugs in capsules and tablets

Product Code	Capacity ml	Approx O.D. x Height mm	Quantity Per Case
4270029	1000	132 x 168	6

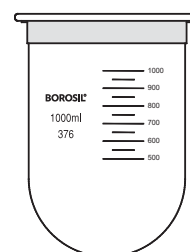

Flasks

## 4315 - Flasks, Boiling, Pear Shaped, Short Neck with Interchangeable Joint

- Made of 3.3 borosilicate glass
- The conical shape makes them ideal for small scale reaction
- Large labelling field

Product Code	Capacity ml	Interchangeable Joint Size	Quantity Per Case
4315005	5	10 / 19	10
4315105	5	14 / 23	10
4315006	10	10 / 19	10
4315106	10	14 / 23	10
4315009	25	14 / 23	5
4315012	50	14 / 23	10





### 4320 - Flasks, Pear Shape Suitable for Rotary Evaporators with Ground Socket

- Rota Vapour Flasks are used along with Rotary Evaporators
- Ideal for heating sensitive solvent solute combinations
- Facilitate the extraction of key components like odour, oil, drugs, natural extract and fragrance

Product Code	Capacity ml	Interchangeable Joint Size	Quantity Per Case
4320112	50	24 / 29	2
4320012	50	29 / 32	2
4320116	100	24 / 29	2
4320016	100	29 / 32	2
4320121	250	24 / 29	2
4320021	250	29 / 32	2
4320124	500	24 / 29	2
4320024	500	29 / 32	2
4320129	1000	24 / 29	2
4320029	1000	29 / 32	2
4320130	2000	24 / 29	2
4320030	2000	29 / 32	2

### 4330 - Flasks, (Vessels) Reaction, Wide Mouth with Flat Flange, 100 mm ID, 150mm OD

- These Flasks have a spherical body with a neck of inner diameter 4 inches (approx 100 mm)
- The top is finely ground to ensure a leak-resistant fit with the cover

Product Code	Capacity ml	Approx Height mm	Quantity Per Case
4330029	1000	170	2
4330030	2000	205	2
4330033	5000	260	2
4330038	10000	335	1
4330040	20000	400	1

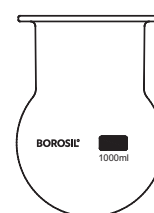

Flasks

### 4331-Lids, for Flasks Reaction Cat No. 4330, Flat Flange and Interchangeable Joint

Product Code	Interchangeable Joint Size					Quantity Per Case
	Centre	Parellel	Side 5°	Side 10°	Side 15°	
4331Z97	19 / 26	19 / 26	24 / 29	19 / 26	-	2
4331Z98	19 / 26	14 / 23	14 / 23	14 / 23	29 / 32	2
4331Z99	29 / 32	14 / 23	14 / 23	14 / 23	29 / 32	2

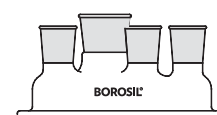



### 4380 - Flasks, Boiling, Round Bottom, With Interchangeable Joint, ISO 4797

- Made of 3.3 borosilicate glass
- Uniform wall thickness distribution and the round - bottom shape make them ideal for heating
- Generally used in distillation and extraction processes
- Large labelling field

Product Code	Capacity ml	Approx Height mm	Interchangeable Joint	Quantity Per Case
4380A09D	25	14 / 23	41 x 85	10
4380A12D	50	14 / 23	51 x 90	5
4380A16D	100	14 / 23	64 x 105	20
4380B09D	25*	19 / 26	41 X 85	10
4380B12D	50	19 / 26	51 X 90	5
4380B16D	100	19 / 26	64 X 105	20
4380B29D	1000	24 / 29	131 X 200	10
4380B30D	2000	29 / 32	166 X 240	4
4380C12D	50*	24 / 29	51 x 105	5
4380C16D	100	24 / 29	64 x 105	20
4380C21D	250	24 / 29	85 x 140	20
4380C24D	500	24 / 29	105 x 163	10
4380C29D	1000	24 / 29	131 X 200	5
4380D12D	50*	29 / 32	51 x 105	20
4380D16D	100	29 / 32	64 x 105	20
4380D21D	250	29 / 32	85 X 140	20
4380D24D	500	29 / 32	105 X 163	10
4380E24D	500*	45 / 40	105 x 163	10
4380D30D	2000*	45 / 40	166 x240	4
4380E29D	1000*	45 / 40	131 x 200	5
4380E32D	4000	45 / 40	207 x 290	2

\* Not covered in standard



## 4381 - Flasks, Round Bottom, Two Necks, Centre Neck and One Angled Side Neck, With Interchangeable Joints

- Uniform wall thickness distribution and the round-bottom shape make them ideal for heating
- The shape facilitates uniform heating
- Accessories, thermometer, column, dropping funnels, boiling capillaries, etc., can be fitted depending upon the application
- Generally used in distillation and extraction processes
- One neck is centred and vertical. The side neck is inclined at an angle of 20° to the vertical neck

Product Code	Capacity ml	Interchangeable Joint Size		Quantity Per Case
		Centre Neck	Side Neck	
4381A16	100	19 / 26	14 / 23	4
4381B16	100	24 / 29	14 / 23	4
4381C16	100	24 / 29	19 / 26	4
4381A21	250	24 / 29	14 / 23	4
4381B21	250	24 / 29	19 / 26	4
4381A24	500	24 / 29	14 / 23	4
4381B24	500	24 / 29	19 / 26	4
4381A29	1000	24 / 29	14 / 23	2
4381B29	1000	24 / 29	19 / 26	2
4381A30	2000	24 / 29	14 / 23	2
4381B30	2000	24 / 29	19 / 26	2
4381C30	2000	34 / 35	19 / 26	2
4381A31	3000	34 / 35	19 / 26	2
4381B31	3000	34 / 35	24 / 29	2
4381A33	5000	34 / 35	19 / 26	1
4381B33	5000	34 / 35	24 / 29	1
4381A38	10000	34 / 35	24 / 29	1
4381B38	10000	55 / 44	24 / 29	1
4381A40	20000	55 / 44	24 / 29	1

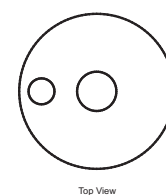



## 4382-Flasks, Round Bottom, Two Necks, Centre Neck and One Parallel Side Neck, with interchangeable Joints

- Uniform wall thickness distribution and the round-bottom shape make them ideal for heating
- The shape facilitates uniform heating
- Accessories, thermometer, column, dropping funnels, boiling capillaries, etc., can be fitted depending upon the application
- Generally used in distillation and extraction processes
- Both the necks are vertical. One neck is centred, while the other is the side neck

Product Code	Capacity ml	Interchangeable Joint Size		Quantity Per Case
		Centre Neck	Side Neck	
4382A16	100	19 / 26	14 / 23	4
4382B16	100	24 / 29	14 / 23	4
4382C16	100	24 / 29	19 / 26	4
4382A21	250	24 / 29	14 / 23	4
4382B21	250	24 / 29	19 / 26	4
4382A24	500	24 / 29	14 / 23	4
4382B24	500	24 / 29	19 / 26	4
4382A29	1000	24 / 29	14 / 23	2
4382B29	1000	24 / 29	19 / 26	2
4382A30	2000	24 / 29	14 / 23	2
4382B30	2000	24 / 29	19 / 26	2
4382C30	2000	34 / 35	19 / 26	2
4382A31	3000	34 / 35	19 / 26	2
4382B31	3000	34 / 35	24 / 29	2
4382A33	5000	34 / 35	19 / 26	1
4382B33	5000	34 / 35	24 / 29	1
4382A38	10000	34 / 35	24 / 29	1
4382B38	10000	55 / 44	24 / 29	1
4382A40	20000	55 / 44	24 / 29	1

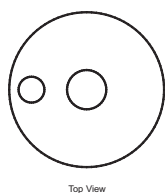

Top View

## 4383 - Flasks, Round Bottom, Three Necks, Centre Neck and Two Angled Side Necks, with interchangeable Joints

- Uniform wall thickness distribution and round-bottom shape make them ideal for heating
- The shape facilitates uniform heating
- Accessories, thermometer, column, dropping funnels, boiling capillaries, etc. can be fitted depending upon the application
- Generally used in distillation and extraction processes
- The centred neck is vertical. The two side necks are 180° apart and are inclined at an angle of 20° to the vertical neck

Product Code	Capacity ml	Interchangeable Joint Size			Quantity Per Case
		Centre Neck	Side Neck	Side Neck	
4383A16	100	19 / 26	14 / 23	14 / 23	4
4383B16	100	14 / 23	14 / 23	14 / 23	4
4383C16	100	24 / 29	14 / 23	14 / 23	4
4383D16	100	24 / 29	19 / 26	19 / 26	4
4383A21	250	19 / 26	14 / 23	14 / 23	4
4383B21	250	19 / 26	19 / 26	19 / 26	4
4383C21	250	24 / 29	14 / 23	14 / 23	4
4383D21	250	24 / 29	19 / 26	19 / 26	4
4383A24	500	19 / 26	14 / 23	14 / 23	4
4383B24	500	19 / 26	19 / 26	19 / 26	4
4383C24	500	24 / 29	14 / 23	14 / 23	4
4383D24	500	24 / 29	19 / 26	19 / 26	4
4383A29	1000	24 / 29	14 / 23	14 / 23	2
4383B29	1000	24 / 29	19 / 26	19 / 26	2
4383C29	1000	34 / 35	24 / 29	24 / 29	2
4383D29	1000	34 / 35	19 / 26	19 / 26	2
4383A30	2000	24 / 29	14 / 23	14 / 23	2
4383B30	2000	24 / 29	19 / 26	19 / 26	2
4383C30	2000	34 / 35	19 / 26	19 / 26	2
4383D30	2000	34 / 35	24 / 29	24 / 29	2
4383A31	3000	34 / 35	19 / 26	19 / 26	2
4383B31	3000	34 / 35	24 / 29	24 / 29	2
4383A33	5000	34 / 35	19 / 26	19 / 26	1
4383B33	5000	34 / 35	24 / 29	24 / 29	1
4383C33	5000	45 / 40	24 / 29	24 / 29	1
4383A38	10000	34 / 35	19 / 26	19 / 26	1
4383B38	10000	34 / 35	24 / 29	24 / 29	1
4383C38	10000	45 / 40	24 / 29	24 / 29	1
4383A40	20000	55 / 44	24 / 29	24 / 29	1

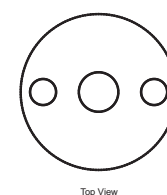
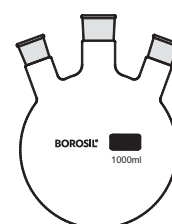

Flasks

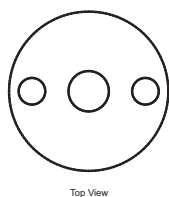
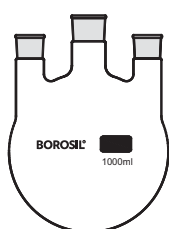

Top View

### 4384 - Flask, Round Bottom, Three Necks, Centre Neck and Two Parallel Side Necks with interchangeable Joints

- Uniform wall thickness distribution and round-bottom shape make them ideal for heating
- The shape facilitates uniform heating
- Accessories, thermometer, column, dropping funnels, boiling capillaries, etc. can be fitted depending upon the application
- Generally used in distillation and extraction processes
- All the three necks are vertical. The two side necks are 180° apart

Product Code	Capacity ml	Interchangeable Joint Size			Quantity Per Case
		Centre Neck	Side Neck	Side Neck	
4384A16	100	19 / 26	14 / 23	14 / 23	4
4384B16	100	14 / 23	14 / 23	14 / 23	4
4384C16	100	24 / 29	14 / 23	14 / 23	4
4384D16	100	24 / 29	19 / 26	19 / 26	4
4384A21	250	19 / 26	14 / 23	14 / 23	4
4384B21	250	19 / 26	19 / 26	19 / 26	4
4384C21	250	24 / 29	14 / 23	14 / 23	4
4384D21	250	24 / 29	19 / 26	19 / 26	4
4384A24	500	19 / 26	14 / 23	14 / 23	4
4384B24	500	19 / 26	19 / 26	19 / 26	4
4384C24	500	24 / 29	14 / 23	14 / 23	4
4384D24	500	24 / 29	19 / 26	19 / 26	4
4384A29	1000	24 / 29	14 / 23	14 / 23	2
4384B29	1000	24 / 29	19 / 29	19 / 26	2
4384C29	1000	34 / 35	24 / 29	24 / 29	2
4384D29	1000	34 / 35	19 / 26	19 / 26	2
4384A30	2000	24 / 29	14 / 23	14 / 23	2
4384B30	2000	24 / 29	19 / 26	19 / 26	2
4384C30	2000	34 / 35	19 / 26	19 / 26	2
4384D30	2000	34 / 35	24 / 29	24 / 29	2
4384A31	3000	34 / 35	19 / 26	19 / 26	2
4384B31	3000	34 / 35	24 / 29	24 / 29	2
4384A33	5000	34 / 35	19 / 26	19 / 26	1
4384B33	5000	34 / 35	24 / 29	24 / 29	1
4384C33	5000	45 / 40	24 / 29	24 / 29	1
4384A38	10000	34 / 35	19 / 26	19 / 26	1
4384B38	10000	34 / 35	24 / 29	24 / 29	1
4384C38	10000	45 / 40	24 / 29	24 / 29	1
4384A40	20000	55 / 44	24 / 29	24 / 29	1

## 4385-Flasks, Round Bottom, Four Necks, Centre Neck and Three Angled Side Neck, with Interchangeable Joints

- Uniform wall thickness distribution and round-bottom shape make them ideal for heating
- The shape facilitates uniform heating
- Accessories, thermometer, column, dropping funnels, boiling capillaries, etc. can be fitted depending upon the application
- Generally used in distillation and extraction processes
- The centred neck is vertical. All the three side necks are inclined at an angle of 20° to the vertical neck
- The two side necks are 180° apart, and a third side neck is at 90° from the other two necks

Product Code	Capacity ml	Interchangeable Joint Size		Quantity Per Case
		Centre Neck	Side Neck	
4385A12	50	24 / 29	24 / 29	4
4385A16	100	24 / 29	14 / 23	4
4385B16	100	24 / 29	19 / 26	4
4385A21	250	24 / 29	14 / 23	4
4385B21	250	24 / 29	19 / 26	4
4385A24	500	24 / 29	14 / 23	4
4385B24	500	24 / 29	19 / 26	4
4385C24	500	24 / 29	24 / 29	4
4385D24	500	34 / 35	24 / 29	4
4385A29	1000	24 / 29	14 / 23	2
4385B29	1000	24 / 29	19 / 26	2
4385C29	1000	24 / 29	24 / 29	2
4385D29	1000	34 / 35	24 / 29	2
4385A30	2000	24 / 29	14 / 23	2
4385B30	2000	24 / 29	19 / 26	2
4385C30	2000	34 / 35	19 / 26	2
4385D30	2000	34 / 35	24 / 29	2
4385A31	3000	34 / 35	19 / 26	2
4385B31	3000	34 / 35	24 / 29	2
4385A33	5000	34 / 35	19 / 26	1
4385B33	5000	34 / 35	24 / 29	1
4385A38	10000	55 / 44	24 / 29	1
4385B38	10000	34 / 35	24 / 29	1
4385A40	20000	55 / 44	24 / 29	1

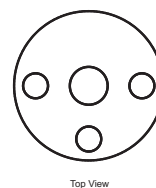
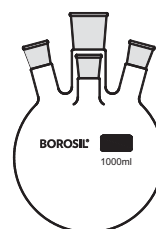

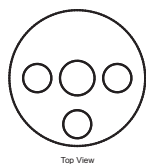
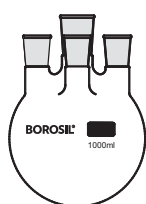

Top View

### 4386 - Flasks, Round Bottom, Four Necks, Centre Neck and Three Parallel Side Neck, with Interchangeable Joints

- Uniform wall thickness distribution and the round-bottom shape make them ideal for heating
- The shape facilitates uniform heating
- Accessories, thermometer, column, dropping funnels, boiling capillaries, etc. can be fitted depending upon the application
- Generally used in distillation and extraction processes
- All the four necks are vertical. The two side necks are 180° apart
- The third neck is at 90° from the other two necks

Product Code	Capacity ml	Interchangeable Joint Size		Quantity Per Case
		Centre Neck	Side Neck	
4386A12	50	24 / 29	24 / 29	4
4386A16	100	24 / 29	14 / 23	4
4386B16	100	24 / 29	19 / 26	
4386A21	250	24 / 29	14 / 23	4
4386B21	250	24 / 29	19 / 26	4
4386A24	500	24 / 29	14 / 23	4
4386B24	500	24 / 29	19 / 26	4
4386C24	500	24 / 29	24 / 29	4
4386D24	500	34 / 35	24 / 29	4
4386A29	1000	24 / 29	14 / 23	2
4386B29	1000	24 / 29	19 / 26	2
4386C29	1000	24 / 29	24 / 29	2
4386D29	1000	34 / 35	24 / 29	2
4386A30	2000	24 / 29	14 / 23	2
4386B30	2000	24 / 29	19 / 26	2
4386C30	2000	34 / 35	19 / 26	2
4386D30	2000	34 / 35	24 / 29	2
4386A31	3000	34 / 35	19 / 26	2
4386B31	3000	34 / 35	24 / 29	2
4386A33	5000	34 / 35	19 / 26	1
4386B33	5000	34 / 35	24 / 29	1
4386A38	10000	55 / 44	24 / 29	1
4386B38	10000	34 / 35	24 / 29	1
4386A40	20000	55 / 44	24 / 29	1

## 4422 - Flasks, Culture, Haffkine

- Complies with IS 7183
- The large, flat bottom surface ensures uniform culture growth
- Typically used for the preparation of culture in nutrient media

Product Code	Capacity ml	Approx O.D. x Height mm	Quantity Per Case
4422031	3000*	245 x 280	2
4422032	4000	246 x 310	2

\*3000 ml not covered in standards

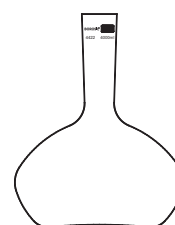

Flasks

## 4620 - Flasks, Distilling, With Side Arm

- Complies with IS 2620
- Uniform wall thickness distribution makes these Flasks ideal for heating
- Suitable for distillation process

Product Code	Capacity ml	Approx O.D. x Height mm	Approx Neck O.D. mm	Quantity Per Case
4620016	100	64 x 210	21	4
4620017	*125	70 x 215	21	4
4620021	250	85 x 230	25	4
4620024	500	105 x 250	28	4
4620029	1000	130 x 305	31	4

\* Specification as per the Institute of Petroleum Standard No. IP 123/64





### 4621 - Flasks, Distilling with I/C joint 19/26 as per ASTM D86

Product Code	Capacity ml	Approx O.D. x Height mm	Approx Neck I. D.	Inter-changeable Joint	Quantity Per Case
4621017	125	70 x 218	19	19 / 26	20



### 4980 - Flasks, Erlenmeyer, Conical, Narrow Mouth

- Complies with IS 1381(Part I), DIN / ISO 1773
- Uniform wall thickness distribution makes these Flasks ideal for heating
- The conical form makes them suitable for mixing liquids
- The easy-to-read scale and large labelling field facilitate easy marking
- Graduated from 25 ml to 5000 ml

Product Code	Capacity ml	Approx O.D. x Height mm	Approx Neck O.D. mm	Quantity Per Case
4980006	10*	37 x 60	15	30
4980009	25	40 x 75	22	40
4980012	50	51 x 90	22	100
4980016	100	64 x 105	22	100
4980017	125*	66 x 110	28	100
4980018	150*	72 x 124	28	100
4980021	250	85 x 145	34	40
4980024	500	105 x 180	38	40
4980029	1000	131 x 220	42	20
4980030	2000	166 x 280	52	20
4980031	3000	187 x 310	48	4
4980033	5000	220 x 365	50	2

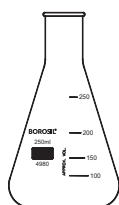

25 ml to 5000 ml Graduated

\*Not covered in standards



### 4981 - Flasks, Erlenmeyer, Conical, Long Neck without Rim

- Uniform wall thickness distribution makes these Flasks ideal for heating
- Ideal for culture work
- Long neck designed for cotton plugs and metal caps
- The conical form makes them suitable for mixing liquids
- The easy-to-read scale and large labelling field facilitate easy marking

Product Code	Capacity ml	Approx O.D. x Height mm	Approx Neck O.D. mm	Quantity Per Case
4981021	250	78 x 154	27	10

Suitable for culture work, designed for cotton plug or metal caps

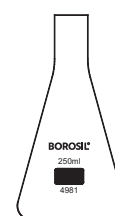

### 4982 - Flasks, Conical, Without Rim

- Uniform wall thickness distribution makes these Flasks ideal for heating
- Ideal for culture work
- Designed without a rim for use in the shaker machine
- The conical form makes them suitable for mixing liquids
- The easy-to-read scale and large labelling field facilitate easy marking

Product Code	Capacity ml mm	Approx O.D. x Height mm	Approx Neck O.D.	Quantity Per Case
4982027	750	114 x 210	42	10

Suitable for culture work, designed for use in shaker machine



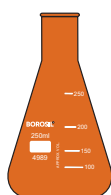

#### 4989 - Flasks, Erlenmeyer, Graduated, Conical, Amber with Narrow Mouth

- Complies with IS 1381 (Part I), DIN / ISO 1773
- Uniform wall thickness distribution makes these Flasks ideal for heating
- The conical form makes them suitable for mixing liquids
- The easy-to-read scale and large labelling field facilitate easy marking
- Graduated from 25 ml to 5000 ml
- Coloured in Amber to protect light-sensitive material
- The Amber colour is applied only to the external surface to prevent contamination with the testing material

Product Code	Capacity ml	Approx O.D. x Height mm	Approx Neck O.D. mm	Quantity Per Case
4989016	100	54 x 105	25	10
4989018	150*	72 x 124	28	10
4989021	250	85 x 145	34	10
4989024	500	104 x 180	38	10
4989029	1000	131 x 220	42	10

Similar in design to Cat. No. 4980

\* Not covered in standards

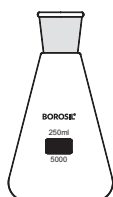

#### 5000 - Flasks, Erlenmeyer, Conical, Narrow Mouth with interchangeable Joint

- Complies with IS 1381 (Part II), EN ISO 4797
- Uniform wall thickness distribution makes these Flasks ideal for heating
- The conical form makes them suitable for mixing of liquids
- The easy-to-read scale and large labelling field facilitate easy marking
- Equipped with interchangeable joints

Product Code	Capacity ml	Interchangeable Joint	Quantity Per Case	
5000009	25	14 / 23	10	
5000012	50	19 / 26	10	
5000016	100	24 / 29	10	
5000021	250	24 / 29	10	
5000024	500	24 / 29	5	

## 5015 - Flasks, Tilt Measure

- Ideal for dispensing fixed volume of liquid
- Easy to use
  - Tilt the unit backward to fill
  - Tilt the unit forward to dispense
- Accuracy  $\pm 5\%$  can be achieved
- Manufactured from chemically resistance 3.3 borosilicate tubing

Product Code	Capacity ml	Flask Capacity ml	Quantity Per Case
5015005	5	100	5
5015006	10	250	5
5015008	20	250	10
5015009	25	250	10
5015012	50	250	10

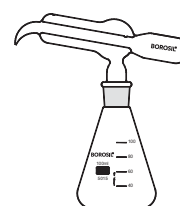

Flasks

## 5019 - Flasks, Erlenmeyer, Conical, Narrow Mouth with Interchangeable Stopper, Amber

- Uniform wall thickness distribution makes these Flasks ideal for heating
- The conical form makes them suitable for mixing of liquids
- These Flasks can be closed with a glass stopper
- Coloured in Amber to protect light-sensitive material
- The Amber colour is applied only to the external surface to prevent contamination with the testing material

Product Code	Capacity ml	Interchangeable Joint	Quantity Per Case
5019009	25	14 / 23	10
5019012	50	19 / 26	10
5019016	100	24 / 29	20
5019021	250	24 / 29	20
5019024	500	24 / 29	10





### 5020 - Flasks, Erlenmeyer, Conical, Narrow Mouth with Interchangeable Stopper

- Uniform wall thickness distribution makes these Flasks ideal for heating
- The conical form makes them suitable for mixing of liquid
- These Flasks can be closed with a glass stopper

Product Code	Capacity ml	Interchangeable Joint	Quantity Per Case
5020009	25	14 / 23	10
5020012	50	19 / 26	10
5020016	100	24 / 29	20
5020021	250	24 / 29	20
5020024	500	24 / 29	10
5020029	1000	29 / 32	10
5020030	2000	29 / 32	10



### 5021 - Flasks, Conical with Screw Cap

- Uniform wall thickness distribution makes these Flasks ideal for heating
- The conical form makes them suitable for mixing of liquids
- These Flasks can be closed with a screw cap
- The caps are made of PP

Product Code	Capacity ml	Neck Specification	Quantity Per Case
5021016	100	GL 25	20
5021018	150	GL 25	20
5021021	250	GL 45	20
5021024	500	GL 45	10
5021029	1000	GL 45	10
5021030	2000	GL 45	10
5021033	5000	GL 45	2



## 5100 - Flasks, Erlenmeyer, Conical, Wide Mouth

- Complies with ISO / 24450 : 2005
- Uniform wall thickness distribution makes these Flasks ideal for heating
- The conical form makes them suitable for mixing of liquids
- The easy-to-read scale and large labelling field facilitate easy marking
- Designed with a wide neck that makes cleaning and filling easier

Product Code	Capacity ml	Approx O.D. x Height mm	Approx Neck O.D. mm	Quantity Per Case
5100012D	50	51 x 85	34	40
5100016D	100	64 x 105	34	20
5100021D	250	85 x 140	50	30
5100024D	500	105 x 175	50	20
5100029D	1000	131 x 220	50	10
5100030D	2000	153 x 276	72	10

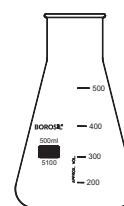

## 5340 - Flasks, Filtering, Bolt Neck, with Tubulation

- These Flasks are blown in special moulds
- The shape is designed to impart maximum mechanical strength
- The neck finish is designed for strength and to ensure good stopper fit
- Ideal for use with Bucher Funnel Category No. 36060 and Gooch Crucible No. 32060 with Sintered Discs that have different porosities

Product Code	Capacity ml	Approx O.D. x Height mm	Quantity Per Case
5340012	50	52 x 86	30
5340016	100	64 x 108	20
5340021	250	85 x 155	10
5340024	500	105 x 184	20
5340029	1000	136 x 227	10
5340030	2000	168 x 270	5
5340033	5000	237 x 390	2
5340038	10000*	230 x 488	1
5340040	20000*	290 x 580	1

\*These flasks are bottle shaped





### 5400-Flasks, Iodine Determination, with Interchangeable Stopper

- These Flasks are made especially for the determination of Iodine value according to the methods of ASTM D-29
- Large labelling field for easy marking
- The handle of the stopper projects above the liquid seal, facilitating its removal

Product Code	Capacity ml	Interchangeable Joint Size	Quantity Per Case
5400016	100	24 / 29	10
5400021	250	24 / 29	10
5400024	500	24 / 29	10



### 5420 - Flasks, Kjeldahl, Round Bottom, Long Neck

- These Flasks are specially designed for nitrogen/protein determination as per the Kjeldahl method
- Designed with a tooled neck for greater strength and a better stopper fit

Product Code	Capacity ml	Approx O.D. x Height mm	Quantity Per Case
5420006	10	30 x 180	10
5420010	30	40 x 180	10
5420016	100	61 x 210	10
5420022	300	80 x 298	10
5420024	500	100 x 325	10
5420028	800	113 x 375	10

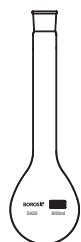

## 5430 - Flasks, Kjeldahl, Round Bottom, Interchangeable Joint

- These Flasks are specially designed for nitrogen/protein determination as per Kjeldahl method.
- Designed with a tooled neck for greater strength and better stopper fit
- The Flask with 500ml capacity is a part of Ammonia Distilling Apparatus Category No. 3340

Product Code	Capacity ml	Approx O.D. x Height mm	Interchangeable Joint Size	Quantity Per Case
5430024	500	100 x 320	24 / 29	10
5430028	800	113 x 375	24 / 29	10

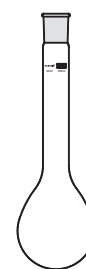

# Pharmacopeal Products

Flasks



5200 - Arsenic Determination Apparatus as per USP

Product Code	Quantity Per Case
5200001	1

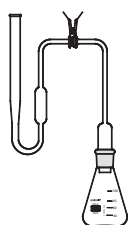

5201 - Arsenic Determination Apparatus Gutzeit

Product Code	Quantity Per Case
5201001	1

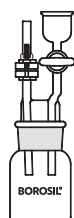



### 5202 - Arsenic Determination Apparatus as per BP

Product Code	Quantity Per Case
5202001	1

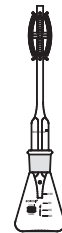
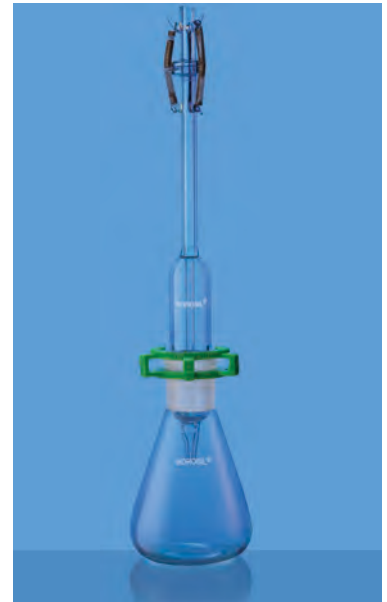

Flasks

### 5203 - Arsenic Determination Apparatus as per IP

Product Code	Quantity Per Case
5203001	1

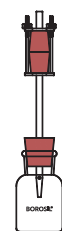



### 5204 - Arsenic Determination Apparatus as per IS

Product Code	Quantity Per Case
5204001	1

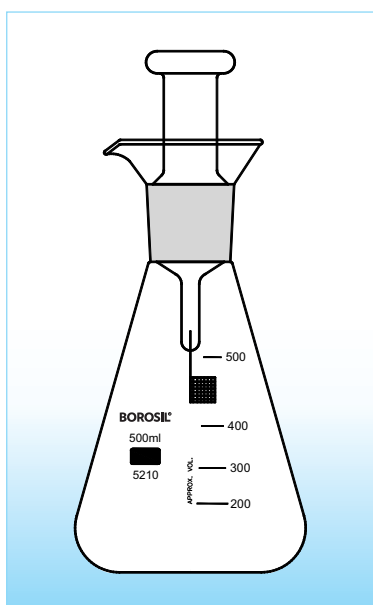
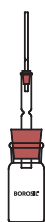

### 5210 - Oxygen Combustion Flask as per USP

- Complies to ASTM E205 - 96
- Manufactured from 3.3 borosilicate, USP Type I glass
- Used for the determination of bromine, chlorine, iodine and sulphur

Product Code	Capacity ml	Quantity Per Case
5210022	300	1
5210024	500	1

### 5211 - Methoxy Determination Assembly as per USP

Product Code	Quantity Per Case
5211024	1

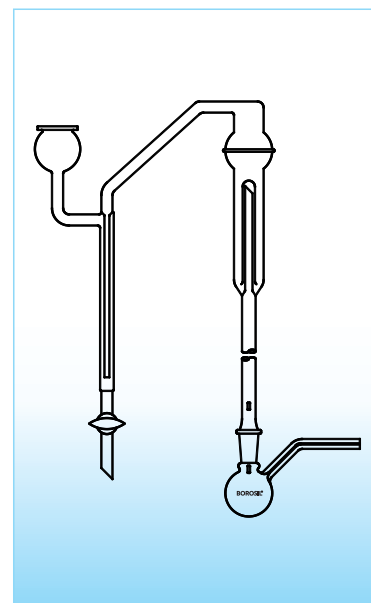

Flasks

### 5212 - Sulphur Di Oxide Assembly as per USP

Product Code	Quantity Per Case
5212024	1

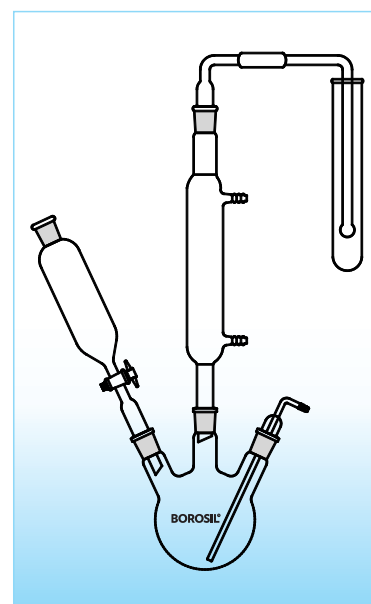

# Filtration Assembly

- HPLC Mobile Phase Filtration
- Analysis of Particulate / bacterial contamination & general laboratory micro-filtration
- Units have G3 coarse porosity Frits & accommodate 47 mm filters / 25 mm filters
- All glass design ensures Chemical Compatibility with Most of the Organic Solvents.

## Application :

- Used for Filtration of HPLC solvents and aqueous mobile phase solutions and buffers.

## Specifications :

- 100% Borosilicate Glass with fritted glass filter base. Base design has integral vacuum connection located above filtrate drip to prevent contamination of vacuum line with droplets.
- Anodized Aluminum Spring clamp
- Filter Size : 47mm
- Effective Filtration Area : 9.6 cm<sup>2</sup>
- Funnel Capacity : 300 ml
- Flask Capacity : 500 ml / 1 Lit / 2 Ltr / 5 Ltr



### 5350 - All Glass Filter Holder - 47mm, Filtration Assembly

- Made of borosilicate glass with fritted glass filter base
- The base design has an integral vacuum connection located above the filtrate drip to prevent contamination of the vacuum line from droplets
- Anodised aluminium spring clamp
- The filter size is 47 mm
- The effective filtration area is 9.6 cm<sup>2</sup>
- Used for filtration of HPLC solvents and aqueous mobile phase solutions and buffers
- The scaled funnels simplify dosing and analysis

Product Code	Capacity ml	Filtration Base Size mm	Quantity Per Case
5350024	500	47	1
5350029	1000	47	1
5350030	2000	47	1

### Spares For All Glass Filter Holder - 47mm

Product Code	Capacity ml	Description
5350124	500 ml	Flask For Filter Holder
5350129	1000 ml	Flask For Filter Holder
5350130	2000 ml	Flask For Filter Holder
5350S01	300 ml	Funnel For Filter Holder
5350S02	47 mm	Filter Support Base For Filter Holder
5350S03	47 mm	Aluminium Clamp for Filter Holder

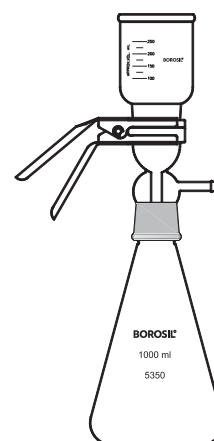

Filtration Assembly

### 5350 - All Glass Filter Holder Assembly - 90mm

Product Code	Capacity ml	Filtration Base Size mm	Quantity Per Case
5350033	5000	90	1

### Spares For All Glass Filter Holder - 90mm

Product Code	Capacity ml	Description
5350133	5000 ml	Flask For Filter Holder With B 55 Cone
5350233	1000 ml	Funnel For Filter Holder Flask
5350333	90 mm	Filter Support Base For Filter Holder
5350433	90 mm	Aluminium Clamp for Filter Holder



### 5360 - All Glass Filter Holder - 47mm, Filtration Assembly

- Made of borosilicate glass with fritted glass filter base
- The base design has an integral vacuum connection located above the filtrate drip to prevent contamination of the vacuum line from droplets
- The filtration base has a silicon stopper
- Anodised aluminium spring clamp
- The filter size is 47mm
- The effective filtration area is 9.6 cm<sup>2</sup>
- Facilitates analysis of particulate or biological contamination of vacuum filtering liquid
- The scaled funnels simplify dosing and analysis

Product Code	Capacity ml	Filtration Base Size mm	Quantity Per Case
5360029	1000	47	1
5360030	2000	47	1

### Spares For All Glass Filter Holder - 47mm

Product Code	Capacity ml	Description
5360129	1000 ml	Flask For Filter Holder
5360130	2000 ml	Flask For Filter Holder
5350S01	300 ml	Funnel For Filter Holder
5360S02	47 mm	Filter Support Base For Filter Holder With Silicon
5350S03	47 mm	Aluminium Clamp for Filter Holder

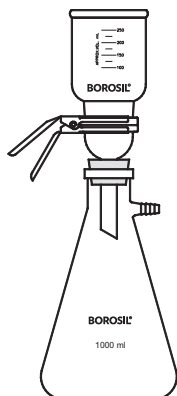

### 5370 - Glass Filter Holder With Silicon Stopper - 25 mm

- Made of borosilicate glass with fritted glass filter base
- The base design has an integral vacuum connection located above the filtrate drip to prevent contamination of the vacuum line from droplets
- The filtration base has a silicon stopper
- Anodised aluminium spring clamp
- The filter size is 25 mm
- The effective filtration area is 9.6 cm<sup>2</sup>
- Facilitates analysis of particulate or biological contamination of vacuum filtering liquid

Product Code	Capacity ml	Filtration Base Size mm	Quantity Per Case
5370017	125	25	1

### Spares For Glass Filter Holder With Silicon Stopper - 25 mm

Product Code	Capacity ml	Description
5370S01	125 ml	Flask For Filter Holder
5370S02	15 ml	Funnel For Filter Holder
5370S03	25 mm	Filter Support Base For Filter Holder With Silicon stopper
5370S04	25mm	Aluminium Clamp for Filter Holder

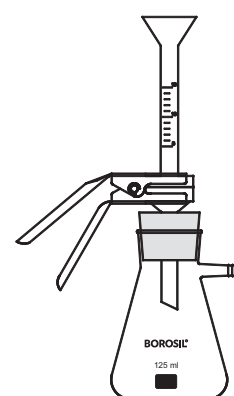

Filtration Assembly

# FLASKS



- Designed to deliver the best combination of
  - Thermal shock resistance
  - Physical strength
  - Resistant to chemical attack
- Flasks are autoclavable

**Manufacturers of Laboratory Glassware**  
From 3.3 Low Expansion Borosilicate Glass



Did  
You  
Know?

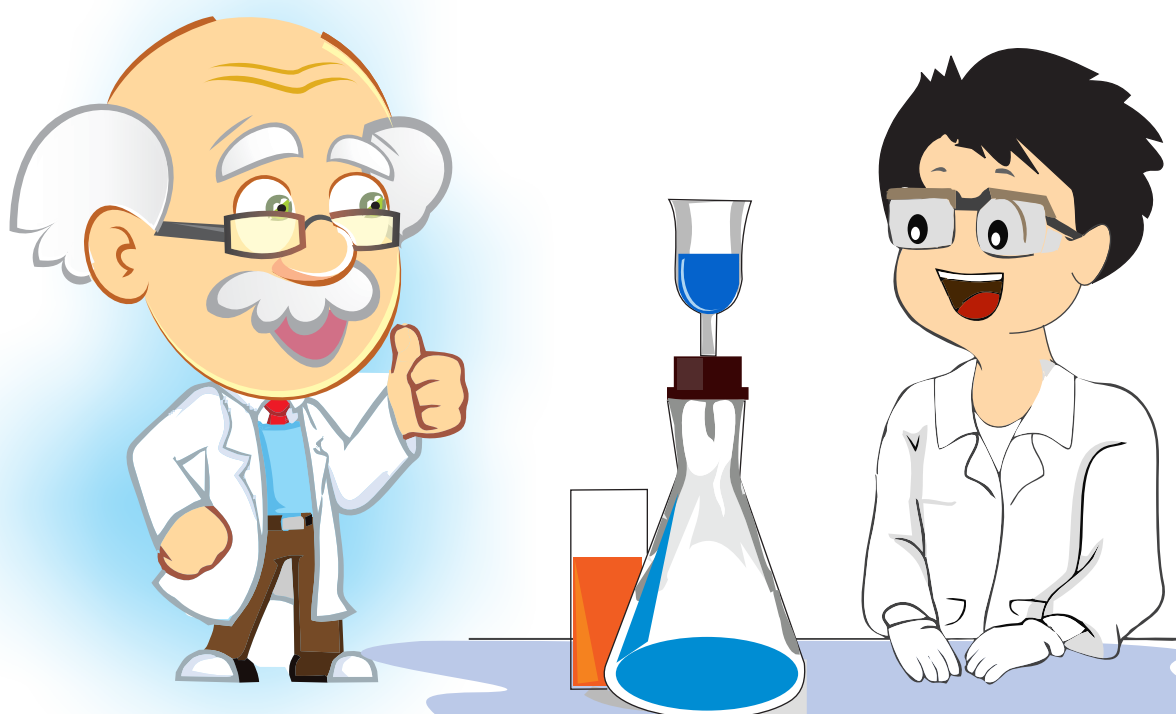

## Funnel

“ Glass funnels is typically used in for lab use rather than metal or plastic because it does not react with chemicals. Solvents can deteriorate plastic or metal funnels. The narrow bottoms of funnels allow liquids to be added to chemical mixtures at a slow pace. ”

**BOROSIL®**

# Volumetric Flask

As the field of chemistry evolves with more research & educational institutions as well as industrial applications expanding day by day, the need for high quality glassware has been felt more than ever before. Be it the preparation of standard solutions or making the right volume with appropriate calibration, Volumetric Glassware offers the right mix of quality and efficiency for numerous objectives.

- Manufactured from 3.3 Low Expansion Borosilicate I. D. control tubing
- Individually calibrated with automatic calibration process
- Comes with highest quality standards according to EN ISO 1042 & USP (E 288)
- Strict quality control through all steps eliminate possible deviations from nominal volume
- Supplied with individual certificate which can be downloaded from our website also
- Volumetric Flasks are supplied with plastic or solid glass stopper



It is a laboratory glassware that is designed to hold a certain volume at a particular temperature and indicates the nominal volume, tolerance, precision class, relevant manufacturing standard etc. The Volumetric Flasks are manufactured in a range of sizes that is capable of containing 1 to 5,000 ml of liquid.

It is very important to understand that for analysis that demands high precision, the selection of instruments is very vital. And in cases where precision analysis is expected, only high accuracy instruments give the desired results. Most sophisticated automatic instruments can deliver high precision results, only if the volumetric ware used to prepare samples is accurate.

Borosil volumetric flasks are designed to give the best combination of thermal shock resistance, physical strength and resistance to chemical attack. They are made to withstand the demands of the modern laboratory and are particularly suitable for all glass apparatus assemblies.

#### Calibration:

- Every Volumetric Flask is calibrated on fully automatic computer controlled calibration machine, eliminating the manual error in reading the meniscus, thereby giving more accurate volume
- Each Volumetric Flask is individually calibrated, provided with unique Code No. and supplied with individual Certificate

#### Printing:

- All Volumetric Flasks are printed with permanent amber colour
- The amber Volumetric Flasks are printed with white ceramic enamel

At **Borosil** we understand that different needs require different solutions. Hence we offer our clients a wide range of flasks, designed to meet their individual requirements, while ensuring optimum quality.

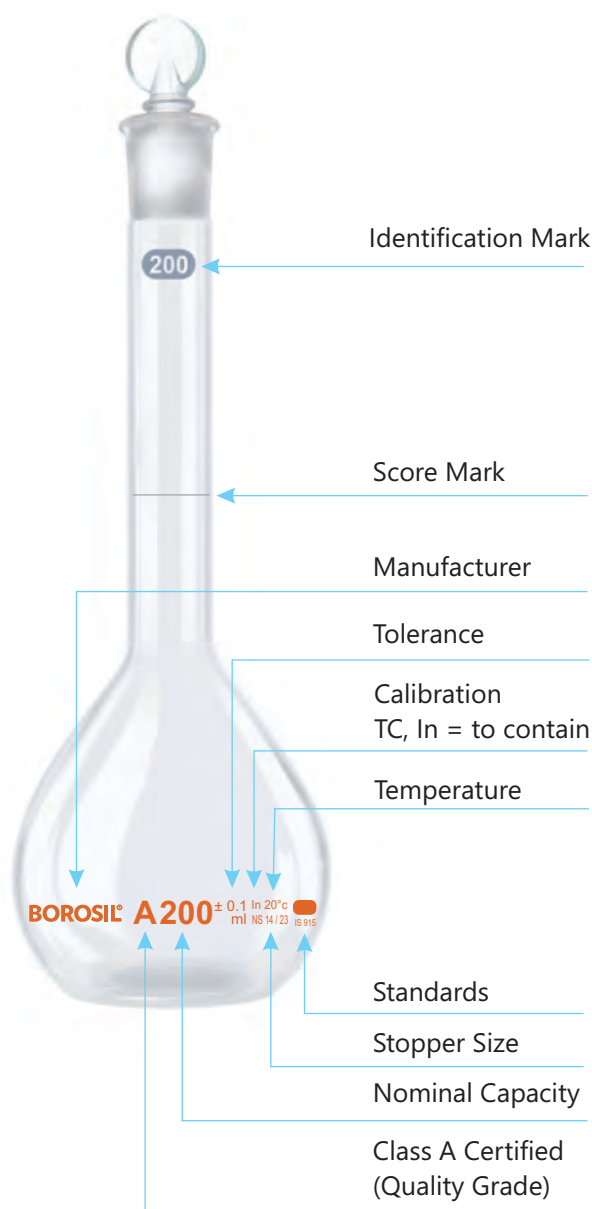

Volumetric Flask

### Trapezoidal Volumetric Flask

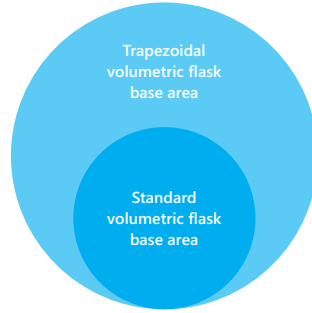

Volumetric flasks with small capacities can be topple down more easily due to their higher centre of gravity.

Trapezoidal volumetric flasks have much larger base area which ensures higher stability. It has atleast twice base area compare to standard volumetric flask of the same capacity.



#### 5639 - Jars, Measuring, with Pour Out, with Works Certificate

- Suitable for measurement of petrol and diesel
- Calibrated as per weight and measure guidelines

Product Code	Capacity ml	Quantity per Case
5639033	5000	1

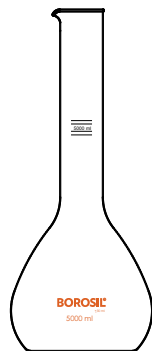

## 5640 - Flasks, Volumetric, with Interchangeable Solid Glass Stopper, Accuracy as per Class A, with Batch Certificate

- Complies with EN ISO 1042
- Manufactured from 3.3 borosilicate, USP Type I glass

Product Code	Capacity ml	Tolerance $\pm$ ml	Stopper Size	Quantity Per Case
5640001A	1	0.025	7 / 16	5
5640002A	2	0.025	7 / 16	5
5640005A	5	0.025	7 / 16	5
5640006A	10	0.025	7 / 16	5
5640008A	20	0.04	10 / 19	5
5640009A	25	0.04	10 / 19	5
5640012A	50	0.06	12 / 21	10
5640016A	100	0.10	14 / 23	10
5640020A	200	0.15	14 / 23	10
5640021A	250	0.15	14 / 23	10
5640024A	500	0.25	19 / 26	10
5640029A	1000	0.40	24 / 29	10
5640030A	2000	0.60	29 / 32	2
5640033A	5000	1.20	34 / 35	2



- \* 1 ml and 2 ml size are of test tube shape
- 5 ml to 20 ml supplied with trapezoidal shape for better stability
- **Certified and Calibrated at 20°C**
- **Individual certificate available on request**

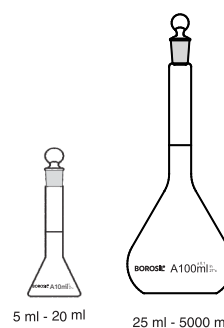

Volumetric Flask



### 5642 - Flasks, Volumetric, with Interchangeable PP Stopper, Accuracy as per Class B

- Complies with ISO / DIN 1042
- Calibrated at 20°C
- Amber enamel inscription
- Manufactured from 3.3 borosilcate glass for corrosion-free performance
- 5 ml to 20 ml supplied with trapezoidal shape for better stability

Product Code	Capacity ml	Tolerance ±ml	Stopper Size	Quantity Per Case
5642001D	1*	0.03	7 / 16	10
5642002D	2*	0.03	7 / 16	10
5642005D	5	0.05	7 / 16	10
5642006D	10	0.05	7 / 16	10
5642008D	20	0.08	10 / 19	10
5642009D	25	0.08	10 / 19	10
5642012D	50	0.12	12 / 21	20
5642016D	100	0.20	14 / 23	20
5642020D	200	0.30	14 / 23	20
5642021D	250	0.30	14 / 23	20
5642024D	500	0.50	19 / 26	20
5642029D	1000	0.80	24 / 29	20
5642030D	2000	1.20	29 / 32	4

- 1ml and 2ml sizes are of test tube shape.

\* Blue enamel inscriptions can be supplied on request

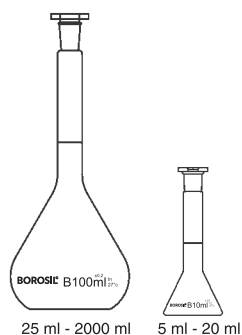

## 5643 - Flask, Wide Mouth Volumetric with Interchangeable PP Stopper Class A, with Batch Certificate

- Complies with EN ISO 1042
- Manufactured from 3.3 borosilicate, USP Type I glass
- Each flask engraved with individual serial number and supplied with certificate of calibration traceable to National standards
- Specially designed wide mouth for testing bigger dia. Tablet without making it in powder form

Product Code	Capacity ml	Tolerance $\pm$ ml	Stopper Size	Quantity Per Case
5643005A	5	0.04	10 / 19	5
5643006A	10	0.04	10 / 19	5
5643008A	20	0.06	12 / 21	5
5643A09A	25	0.06	12 / 21	5
5643012A	50	0.10	14 / 23	10
5643016A	100*	0.15	19 / 26	10
5643020A	200*	0.20	19 / 26	10
5643021A	250*	0.20	19 / 26	10
5643029A	1000	0.60	29 / 32	10

- \* Not covered in the standards

- 5 ml to 20 ml supplied with trapezoidal shape for better stability

- **Certified and Calibrated at 20°C**

- **Individual certificate available on request**

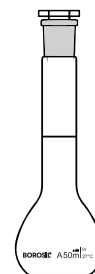

## 8300 - PP Stoppers for Volumetric flasks

Product Code	Interchangeable ml	Quantity per Case
8300007	7 / 16	100
8300A10	10 / 19	100
8300012	12 / 21	100
8300A14	14 / 23	100
8300A19	19 / 26	50
8300A24	24 / 29	50
8300A29	29 / 32	50
8300A34	34 / 35	50

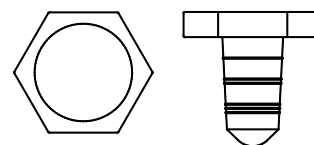



### 5645 - Flasks, Volumetric, with Interchangeable PP Stopper Accuracy as per Class A, USP (US Pharmacopoeia), with Batch Certificate

- Manufactured from 3.3 borosilicate, USP Type I glass
- Calibrated as per USP tolerance ( ASTM E 288)

Product Code	Capacity ml	Tolerance $\pm$ ml	Stopper Size	Quantity Per Case
5645005A	5	0.02	7 / 16	5
5645006A	10	0.02	7 / 16	5
5645008A	20*	0.03	10 / 19	5
5645009A	25	0.03	10 / 19	5
5645012A	50	0.05	12 / 21	10
5645016A	100	0.08	14 / 23	10
5645020A	200	0.10	14 / 23	10
5645021A	250	0.12	14 / 23	10
5645024A	500	0.20	19 / 26	10
5645029A	1000	0.30	24 / 29	10
5645030A	2000	0.50	29 / 32	2

- 5 ml to 20 ml supplied with trapezoidal shape for better stability
- **Certified and Calibrated at 20°C**
- **Individual certificate available on request**

Volumetric Flask

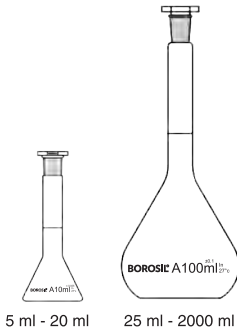

**NABL  
CERTIFIED**

### 2023 - Flasks, Volumetric, With Interchangeable PP Stopper, Accuracy As per Class A With Certificate ASTM E 288, NABL Certified

- Manufactured from 3.3 borosilicate, USP Type I glass for corrosion-free performance

Product Code	Capacity ml	Tolerance $\pm$ ml	Stopper Size	Quantity Per Case
2023005	5	0.02	7 / 16	5
2023006	10	0.02	7 / 16	5
2023008	20	0.03	10 / 19	5
2023009	25	0.03	10 / 19	5
2023012	50	0.05	12 / 21	10
2023016	100	0.08	14 / 23	10
2023020	200	0.10	14 / 23	10
2023021	250	0.20	14 / 23	10
2023024	500	0.20	19 / 26	10
2023029	1000	0.30	24 / 29	10
2023030	2000	0.50	29 / 32	2

- \* 1 ml and 2 ml size are of test tube shape
- 5 ml to 20 ml supplied with trapezoidal shape for better stability
- **Certified and Calibrated at 20°C**



## 5646 - Flasks, Volumetric, With Interchangeable Plastic Stopper, Accuracy As per Class A, With Batch Certificate

- Complies with EN ISO 1042
- Manufactured from 3.3 borosilicate, USP Type I glass

Product Code	Capacity ml	Tolerance $\pm$ ml	Stopper Size	Quantity Per Case
5646001A	1	0.025	7 / 16	5
5646002A	2	0.025	7 / 16	5
5646005A	5	0.025	7 / 16	5
5646006A	10	0.025	7 / 16	5
5646008A	20	0.04	10 / 19	5
5646009A	25	0.04	10 / 19	5
5646012A	50	0.06	12 / 21	10
5646016A	100	0.10	14 / 23	10
5646020A	200	0.15	14 / 23	10
5646021A	250	0.15	14 / 23	10
5646024A	500	0.25	19 / 26	10
5646029A	1000	0.40	24 / 29	10
5646030A	2000	0.60	29 / 32	2
5646033A	5000	1.20	34/35	2

- \* 1ml and 2 ml sizes are of test tube shape
- 5 ml to 20 ml supplied with trapezoidal shape for better stability
- **Certified and Calibrated at 20°C.**
- Individual certificate available on request

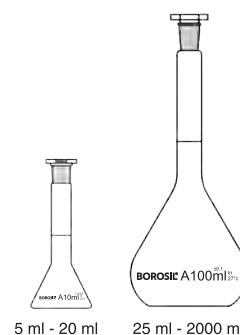

Volumetric Flask



## 2022 - Flasks, Volumetric, With Interchangeable PP Stopper, Accuracy As per Class A With Certificate ISO 1042, NABL Certified

- Manufactured from 3.3 borosilicate, USP Type I glass for corrosion-free performance

Product Code	Capacity ml	Tolerance $\pm$ ml	Stopper Size	Quantity Per Case
2022001	1	0.025	7 / 16	5
2022002	2	0.025	7 / 16	5
2022005	5	0.025	7 / 16	5
2022006	10	0.025	7 / 16	5
2022008	20	0.04	10 / 19	5
2022009	25	0.04	10 / 19	5
2022012	50	0.06	12 / 21	10
2022016	100	0.10	14 / 23	10
2022020	200	0.15	14 / 23	10
2022021	250	0.15	14 / 23	10
2022024	500	0.25	19 / 26	10
2022029	1000	0.4	24 / 29	2
2022030	2000	0.6	29 / 32	2

- \* 1 ml and 2 ml size are of test tube shape
- 5 ml to 20 ml supplied with trapezoidal shape for better stability
- **Certified and Calibrated at 20°C**



## 5647- Flasks, Wide Mouth Volumetric with Interchangeable Solid Glass Stopper, Accuracy As Class A, USP (US Pharmacopoeia) with Batch Certificate

- Calibrated as per USP tolerance ( ASTM E 288)
- Manufactured from 3.3 borosilicate USP Type I glass
- Each flask engraved with individual serial number and supplied with certificate of calibration traceable to National standards
- Specially designed wide mouth for testing bigger dia. Tablet without making it in powder form

Product Code	Capacity ml	Tolerance $\pm$ ml	Stopper Size	Quantity Per Case
5647005A	5	0.08	10 / 19	5
5647006A	10	0.08	10 / 19	5
5647008A	20*	0.08	12 / 21	5
5647009A	25	0.08	12 / 21	5
5647012A	50	0.08	14 / 23	10
5647016A	100	0.10	19 / 26	10
5647020A	200	0.20	19 / 26	10
5647021A	250	0.20	19 / 26	10

- \* Not covered in the standards

- 5 ml to 20 ml supplied with trapezoidal shape for better stability

- **Certified and Calibrated at 20°C**

- Individual certificate available on request

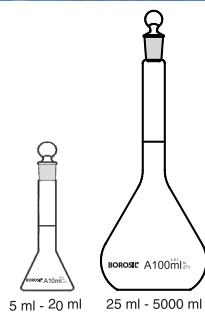

## 5648 - Flasks, Volumetric, with Interchangeable PP Stopper Accuracy as per Class A, Amber, with Batch Certificate

- Complies with EN ISO 1042
- Manufactured from 3.3 borosilicate USP Type I glass with an amber coating on exterior surfaces to facilitate use with light sensitive solutions

Product Code	Capacity ml	Tolerance $\pm$ ml	Stopper Size	Quantity Per Case
5648005A	5	0.025	7 / 16	5
5648006A	10	0.025	7 / 16	5
5648008A	20	0.04	10 / 19	5
5648009A	25	0.04	10 / 19	5
5648012A	50	0.06	10 / 19	10
5648016A	100	0.10	14 / 23	10
5648020A	200	0.15	14 / 23	10
5648021A	250	0.15	14 / 23	10
5648024A	500	0.25	19 / 26	10
5648029A	1000	0.40	24 / 29	10
5648030A	2000	0.60	29 / 32	2
5648033A	5000	1.20	34/35	2

- Individual certificate available on request



Volumetric Flask



### 5650 - Flasks, Volumetric, Sugar Estimation, without Stopper

- Complies with BS 675
- A two mark flask designed for the analysis of sugar solutions. The two graduation marks provide a dilution of 1 in 10

Product Code	Capacity ml	Tolerance $\pm$ ml	Quantity Per Case
5650016	100 / 110	0.15	20

Volumetric Flask

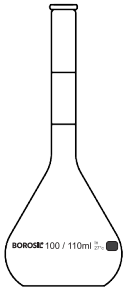

## 5651 - Flask, Volumetric, with Interchangeable Solid Glass Stopper Accuracy Class 'A', Amber Mark, with Certificate

- Complies with EN ISO 1042
- Manufactured from 3.3 borosilicate, USP Type I glass for corrosion-free performance
- Each flask engraved with individual serial number and supplied with certificate of calibration traceable to National standards
- Amber enamel inscriptions
- Special amber colour triangle at neck for easy differentiation. They are also suitable for Cytotoxic test where flasks to be isolated from other glassware

Product Code	Capacity ml	Tolerance $\pm$ ml	Stopper Size	Quantity Per Case
5651001A	1*	0.025	7 / 16	4
5651002A	2*	0.025	7 / 16	4
5651005A	5	0.025	7 / 16	5
5651006A	10	0.025	7 / 16	5
5651008A	20	0.04	10 / 19	5
5651009A	25	0.04	10 / 19	5
5651012A	50	0.06	12 / 21	10
5651016A	100	0.1	14 / 23	10
5651020A	200	0.15	14 / 23	10
5651021A	250	0.15	14 / 23	10
5651024A	500	0.25	19 / 26	10
5651029A	1000	0.40	24 / 29	10
5651030A	2000	0.60	29 / 32	2

- \* 1ml and 2 ml sizes are of test tube shape
- 5 ml to 20 ml supplied with trapezoidal shape for better stability
- **Certified and Calibrated at 20°C.**
- Individual certificate available on request

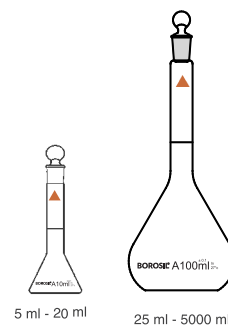

Volumetric Flask



## 5652 - Flask, Volumetric, with Interchangeable Solid Glass Stopper, Accuracy Class 'A', White Mark, Amber with Batch Certificate

- Complies with ISO / DIN 1042
- Manufactured from 3.3 borosilicate USP Type I glass with an amber coating on exterior surfaces to facilitate use with light sensitive solutions
- Each flask engraved with individual serial number and supplied with certificate of calibration traceable to National standards
- White enamel inscriptions
- Special white colour triangle at neck for easy differentiation. They are also suitable for Cytotoxic test where flasks to be isolated from other glassware.

Product Code	Capacity ml	Tolerance $\pm$ ml	Stopper Size	Quantity Per Case
5652005A	5	0.025	7 / 16	5
5652006A	10	0.025	7 / 16	5
5652008A	20	0.04	10 / 19	5
5652009A	25	0.04	10 / 19	5
5652012A	50	0.06	12 / 21	10
5652016A	100	0.1	14 / 23	10
5652020A	200	0.15	14 / 23	10
5652021A	250	0.15	14 / 23	10
5652024A	500	0.25	19 / 26	10
5652029A	1000	0.40	24 / 29	10
5652030A	2000	0.60	29 / 32	2

- 5 ml to 20 ml supplied with trapezoidal shape for better stability

- **Certified and Calibrated at 20°C**

- **Individual certificate available on request**

Volumetric Flask

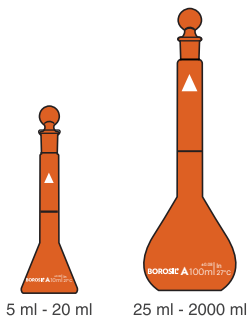

## 5653 - Flasks, Wide Mouth Volumetric with Interchangeable PP Stopper, Class A, Amber with Batch Certificate

- Complies with EN ISO 1042
- Manufactured from 3.3 borosilicate USP Type I glass with an amber coating on exterior surfaces to facilitate use with light sensitive solutions
- Each flask engraved with individual serial number and supplied with certificate of calibration traceable to National standards
- Specially designed wide mouth for testing bigger dia. Tablet without making it in powder form

Product Code	Capacity ml	Tolerance $\pm$ ml	Stopper Size	Quantity Per Case
5653005A	5	0.04	10 / 19	5
5653006A	10	0.04	10 / 19	5
5653008A	20	0.06	12 / 21	5
5653009A	25	0.06	14 / 23	5
5653A09A	AZ25*	0.06	12 / 21	5
5653012A	50	0.10	14 / 23	10
5653016A	100*	0.15	19 / 26	10
5653020A	200*	0.20	19 / 26	10
5653021A	250*	0.20	19 / 26	10
5653029A	1000	0.60	29 / 32	10

- \* Not covered in the standards

- 5 ml to 20 ml supplied with trapezoidal shape for better stability

- **Certified and Calibrated at 20°C**

- **Individual certificate available on request**

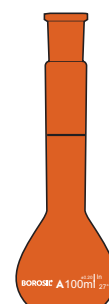

Volumetric Flask



Volumetric Flask

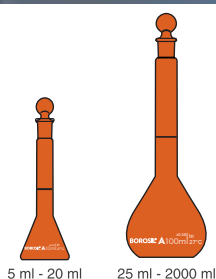

### 5655 - Flasks, Volumetric with Interchangeable Solid Glass Stopper Accuracy as per Class A, USP (US Pharmacopoeia), Amber With Batch Certificate

- Manufactured from 3.3 borosilicate USP Type I glass with an amber coating on exterior surfaces to facilitate use with light sensitive solutions
- Calibrated as per USP tolerance (ASTM E 288)
- Each flask engraved with individual serial number and supplied with certificate of calibration traceable to National standards

Product Code	Capacity ml	Tolerance ±ml	Stopper Size	Quantity Per Case
5655005A	5	0.02	7 / 16	5
5655006A	10	0.02	7 / 16	5
5655008A	20*	0.03	10 / 19	5
5655009A	25	0.03	10 / 19	5
5655012A	50	0.05	12 / 21	10
5655016A	100	0.08	14 / 23	10
5655020A	200	0.10	14 / 23	10
5655021A	250	0.12	14 / 23	10
5655024A	500	0.20	19 / 26	10
5655029A	1000	0.30	24 / 29	10
5655030A	2000	0.50	29 / 32	2

- 5 ml to 20 ml supplied with trapezoidal shape for better stability
- **Certified and Calibrated at 20°C**
- Individual certificate available on request

### 5657- Flasks, Wide Mouth Volumetric with Interchangeable Solid Glass Stopper, Accuracy As Class A, USP (US Pharmacopoeia) Amber with Batch Certificate

- Calibrated as per USP tolerance (ASTM E 288)
- Manufactured from 3.3 borosilicate USP Type I glass
- Each flask engraved with individual serial number and supplied with certificate of calibration traceable to National standards
- Specially designed wide mouth for testing bigger dia. Tablet without making it in powder form

Product Code	Capacity ml	Tolerance ±ml	Stopper Size	Quantity Per Case
5657005A	5	0.08	10 / 19	5
5657006A	10	0.08	10 / 19	5
5657008A	20*	0.08	12 / 21	5
5657009A	25	0.08	12 / 21	5
5657012A	50	0.08	14 / 23	10
5657016A	100	0.10	19 / 26	10
5657020A	200	0.20	19 / 26	10
5657021A	250	0.20	19 / 26	10

- \* Not covered in the standards
- 5 ml to 20 ml supplied with trapezoidal shape for better stability
- **Certified and Calibrated at 20°C**
- Individual certificate available on request





Column chromatography in chemistry is a method used to purify individual chemical compounds from mixtures of compounds. It is often used for preparative applications on scales from micrograms up to kilograms. The main advantage of column chromatography is the relatively low cost and disposability of the stationary phase used in the process. The latter prevents cross-contamination and stationary phase degradation due to recycling.

# Chromatography Columns

## 6100 - Columns, Chromatography, Plain With Glass Stopcock

- Designed with straight bore stopcock that increases the life as compared to PTFE key stopcocks
- The glass stopcock enhances control and facilitates smoother action
- Generally used for purification of individual compounds from mixtures of compounds

Product Code	Approx Effective Length mm	Bore mm	Quantity Per Case
6100060	200	10	5
6100061	300	10	5
6100062	300	18	5
6100063	450	30	5
6100064	500	10	5
6100065	500	18	5
6100066	600	30	5
6100067	600	40	5
6100068	1000	40	4

**Note :** The Columns with Boroflow & PTFE stopcock will be made available on request

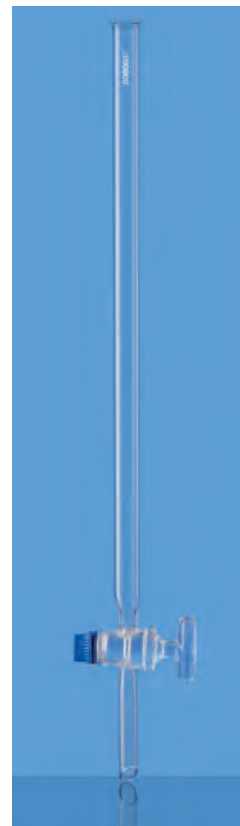
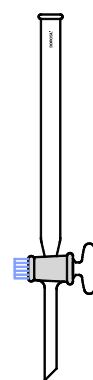

## 6101 - Columns, Chromatography, Plain With Sintered Disc And Glass Stopcock

- Designed with straight bore stopcock that increases the life as compared to PTFE key stopcocks
- The glass stopcock enhances control and facilitates smoother action.
- Columns are added with a Sintered Disc for good results.
- Generally used for purification of individual compounds from mixtures of compounds
- Columns are added with a sintered disk ( Grade I) for good result

Product Code	Approx Effective Length mm	Bore mm	Quantity Per Case
6101060	200	10	5
6101061	300	10	5
6101062	300	18	5
6101063	450	30	5
6101064	500	10	5
6101065	500	18	5
6101066	600	30	5
6101067	600	45	5
6101068	1000	45	4

**Note :** The Columns with Boroflow & PTFE stopcock will be made available on request

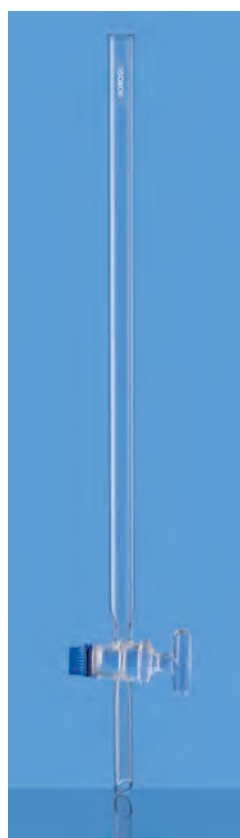
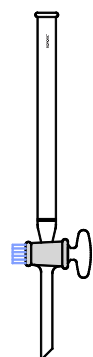

Chromatography Columns

# Funnels

Funnels may be used for separating solids from liquids, liquids from liquids and occasionally, for pouring something into a container.

**BOROSIL®** brand Funnels are available in a comprehensive range for a variety of such applications. Sintered Glass Funnels are also available.

Separating Funnels come in globe, pear and cylindrical shapes with ground glass stopcocks and interchangeable stoppers. These Funnels are made of specially moulded blanks. Stopcock bores, body openings and stems are carefully aligned to facilitate the smooth and even flow of liquid with fast cut-off.



## 6140 - Funnels, Plain, 60° Angle, Short Stem

- Complies with IS 1591, DIN / ISO 4798
- Made 3.3 borosilicate glass, USP Type I
- Designed with a 60° bowl angle to ensure precise fitting of the filter paper
- High thermal shock resistance and chemical resistance
- Generally used for filtering and decanting liquids of varied densities

Product Code	Diameter mm	Quantity Per Case
6140057	25	30
6140058	35	30
6140065	50	20
6140069	65	20
6140071	75	20
6140077	100	40

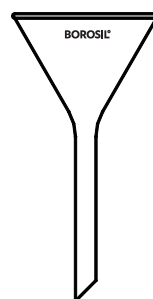

## 6150 - Tubes Funnel Test Tubes

- Specially Designed for Soil testing laboratory

Product Code	Diameter mm	Quantity Per Case
6150007	15	10
6150010	30	10

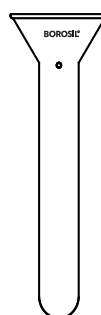

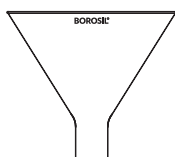

### 6220 - Funnels, Powder

- Ideal for transferring powders
- Designed with a short wide stem to facilitate smooth flow
- Made of chemically resistant 3.3 borosilicate glass

Product Code	Diameter mm	Quantity Per Case
6220080	125	30
6220081	150	20
6220087	200	4
6220089	250	4

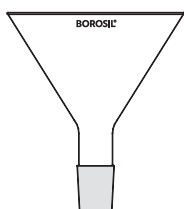

### 6230 - Funnels, Powder, Stem, with Cone

- Ideal for transferring powders
- Designed with a short wide stem to facilitate smooth flow
- Made of chemically resistant 3.3 borosilicate glass
- Supplied with ground glass cone for easy fitting on flask
- Joint size 24 / 29 for all capacities

Product Code	Diameter mm	Quantity Per Case
6230080	125	20
6230081	150	20
6230087	200	4
6230089	250	4

## 6340-Funnels, Separating, Globe Shape, with Stopcock and Interchangeable Stopper

- Made 3.3 borosilicate glass, USP Type I
- Equipped with a standard ground glass stopcock
- Globe shape, with a stem
- Generally used in the separation phase

Product Code	Capacity ml	Stopper Size	Quantity Per Case
6340017	125	19 / 26	10
6340021	250	24 / 29	10
6340024	500	24 / 29	10
6340029	1000	29 / 32	5
6340030	2000	29 / 32	10
6340033	5000	34 / 35	1

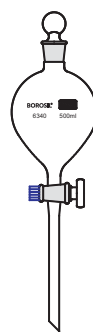

## 6400-Funnels, Separating, Pear Shape, with glass Stopcock and interchangeable Stopper

- Complies with IS 1575, DIN / ISO 4800
- Made 3.3 borosilicate glass, USP Type I
- Equipped with a standard glass stopcock
- Pear shape, with a stem
- Generally used in the separation phase

Product Code	Capacity ml	Stopper Size	Quantity Per Case
6400013	60*	14 / 23	10
6400017	125*	19 / 26	10
6400021	250	24 / 29	10
6400024	500	24 / 29	10
6400029	1000	29 / 32	10
6400030	2000	29 / 32	10

\* Not covered in standards.





### 6402-Funnels, Separating, Pear Shape, Fitted with Boroflo Stopcock with PTFE Key and Interchangeable Stopper

- Complies with IS 1575, DIN / ISO 4800
- Made 3.3 borosilicate glass, USP Type I
- Equipped with a Boroflo stopcock with PTFE key
- Pear shape, with a stem
- Generally used in the separation phase

Product Code	Capacity ml	Stopper Size	Quantity Per Case
6402013	60*	14 / 23	10
6402017	125*	19 / 26	10
6402021	250	24 / 29	10
6402024	500	24 / 29	10
6402029	1000	29 / 32	10
6402030	2000	29 / 32	10

\* Not covered in standards.

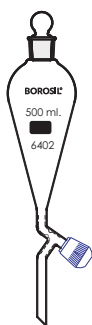

### 6403-Funnels, Separating, Pear Shape, with PTFE Key Stopcock, Interchangeable Stopper

- Complies with IS 1575, DIN / ISO 4800
- Made of 3.3 borosilicate glass
- USP Type I glass
- Equipped with a PTFE key stopcock
- Pear shape, with a stem
- Generally used in the separation phase

Product Code	Capacity ml	Stopper Size	Quantity Per Case
6403017	125*	19 / 26	10
6403021	250	24 / 29	10
6403024	500	24 / 29	10
6403029	1000	29 / 32	10
6403030	2000	29 / 32	10

\* Not covered in standards.

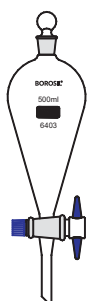

## 6405 - Funnel, Pressure Equilising Cylindrical, with PTFE Stopcock

- Made 3.3 borosilicate glass, USP Type I
- Equipped with totally grease free and self lubricating PTFE stopcock
- Supplied with polypropylene stopper

Product Code	Capacity ml	Socket	Cone	Quantity Per Case
6405012	50	19 / 26	19 / 26	5
6405016	100	19 / 26	19 / 26	5
6405021	250	24 / 29	24 / 29	5
6405024	500	24 / 29	24 / 29	5



## 6408 - Dropping Funnel with Glass Stopcock

- Complies with IS 1575, DIN / ISO 4800

Product Code	Capacity ml	Neck Joint	Quantity Per Case
6408012	50	14 / 23	5
6408016	100	19 / 26	5
6408021	250	24 / 29	5
6408024	500	24 / 29	5
6408029	1000	29 / 32	5





## Gas Generator

Any scientific lab is incomplete without Gas Generator, an instrument that supports a multitude of scientific experiments across institutions and industries. It is a rapid, inexpensive and effective apparatus to produce controllable amounts of common gases such as hydrogen sulphide, carbon dioxide etc.

**BOROSIL®** Gas Generator is an ideal choice with the promise of high quality and precision, thus making it the perfect solution for scientific purposes.

### 6550 - Gas Generator, Kipps

- Manufactured from 3.3 Borosilicate glass USP Type I
- Used to produce common gases
- Simple to operate and quickly charged as well as assembled

Product Code	Extrator Length mm	Quantity Per Case
6550024	500	1
6550029	1000	1

\* Spares available on request

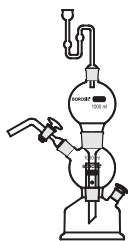

## Jars

The cover of Museum Jar is provided with a small orifice for easy filling of the preservative without unsealing the lid. The excellent resistance to chemical attack and good optical clarity of Borosil® brand jars gives them a clear advantage over others.

### 6910 - Jars, Rectangular, Museum, with Cover, 3.3 Borosilicate glass

- Made from borosilicate glass 3.3 USP Type I
- Specially blown to give sturdiness and long life
- Top edges are flat ground
- Not recommended for use over a direct flame or on a hot plate
- Covers are made from Soda glass

Product Code	Approx Height x Length x Breadth mm	Quantity Per Case
6910M41	200 x 125 x 125	1
6910M42	200 x 150 x 100	1
6910M43	220 x 195 x 80	1
6910M44	250 x 165 x 140	1
6910M45	250 x 250 x 120	1
6910M46	360 x 150 x 100	1

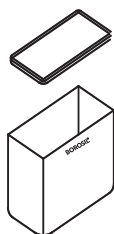



# Kettles

Borosil brand Resin Reaction Kettles are designed for organic reactions involving viscous materials. The wide mouth enables easy access for cleaning the interior. The covers are of heavy construction, while the lower sections are mould-blown to ensure maximum resistance to mechanical breakage. The covers have openings with interchangeable joints to facilitate rapid assembly with Condensers, Stirrers, etc. Flanges of the covers and base are finely ground to ensure a tight seal.

## 6947 - Kettles, Resin Reaction

- Made of 3.3 Borosilicate glass
- Designed for viscous reaction materials
- The wide mouth enables easy access for cleaning the interior
- Flanges of the covers and base are finely ground to ensure a tight seal
- Equipped with interchangeable covers with four openings

Product Code	Capacity ml	Body Dia mm	Height mm	Quantity Per Case Set
6947024	500	95	150	1
6947029	1000	108	175	1
6947030	2000	150	185	1
6947032	4000	150	340	1

The 500 ml and 1000 ml kettles have interchangeable covers with four openings to accommodate 24 / 29 interchangeable joints. Kettles of 2000 ml and 4000 ml capacity have interchangeable covers with openings to accommodate three 24 / 29 interchangeable joints and one 34 / 35 interchangeable joint.



Kettles



### 6948 - Bottoms, Only for Kettles Cat no. 6947

- Made of 3.3 borosilicate glass to ensure maximum resistance to mechanical breakage
- The base has a wide mouth that enables easy access for cleaning the interior
- Flanges of the base are finely ground to ensure a tight seal

Product Code	Capacity ml	Quantity Per Case
6948024	500	2
6948029	1000	2
6948030	2000	2
6948032	4000	2

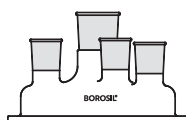

### 6949 - Covers, Only for Kettles Cat No. 6947

- Made of 3.3 borosilicate glass, and made of heavy construction
- The covers have openings with interchangeable joints to facilitate rapid assembly with Condensers and Stirrers
- Flanges of the covers are finely ground to ensure a tight seal

Product Code	Capacity ml	Quantity Per Case
6949041	500 / 1000	2
6949042	2000 / 4000	2

The 500 ml and 1000 ml kettles have interchangeable covers with four openings to accommodate 24 / 29 interchangeable joints. Kettles of 2000 ml and 4000 ml capacity have interchangeable covers with openings to accommodate three 24 / 29 interchangeable joints and one 34 / 35 interchangeable joint.

# Did You Know?

## Pipette

Color coded graduated pipettes aid chemists to easily identify and select the desired pipette in the laboratory.



**BOROSIL®**

Capacity (ml)	Colour Code
1	Blue
2	Orange
3	Black
4	2 Red Rings
5	White
6	2 Orange Rings
7	2 Green Rings
8	Blue
9	Black
10	Red
15	Green
20	Yellow
25	Blue
30	Black
40	White
50	Red
100	Yellow

# Pipettes

**BOROSIL**<sup>®</sup> brand Pipettes are made of specially-selected heavy wall machine-drawn borosilicate accurate bore glass tubing. They have precision formed jets, and bevel ground ends that resist chipping. The graduation marks are made in durable white enamel or amber stain, resistant to normal laboratory reagents and repeated washing. All the Pipettes are individually measured, and then marked. The uniformity of bore ensures accuracy between any two readings. The Pipettes can be autoclaved and, if necessary, can be flamed for sterilisation.

All **Borosil** Pipettes are colour-coded at the top in accordance with ISO Standards, to facilitate easy identification. The graduation marks are screen printed. The mouth piece of Pipettes of 5 ml and above are tooled with uniform OD for easy sucking. Such tooling also imparts additional strength.

Borosil brand Pipettes are truly dependable in terms of their accuracy. They are available in both, Class A with Works Certificate as well as Class B tolerances.

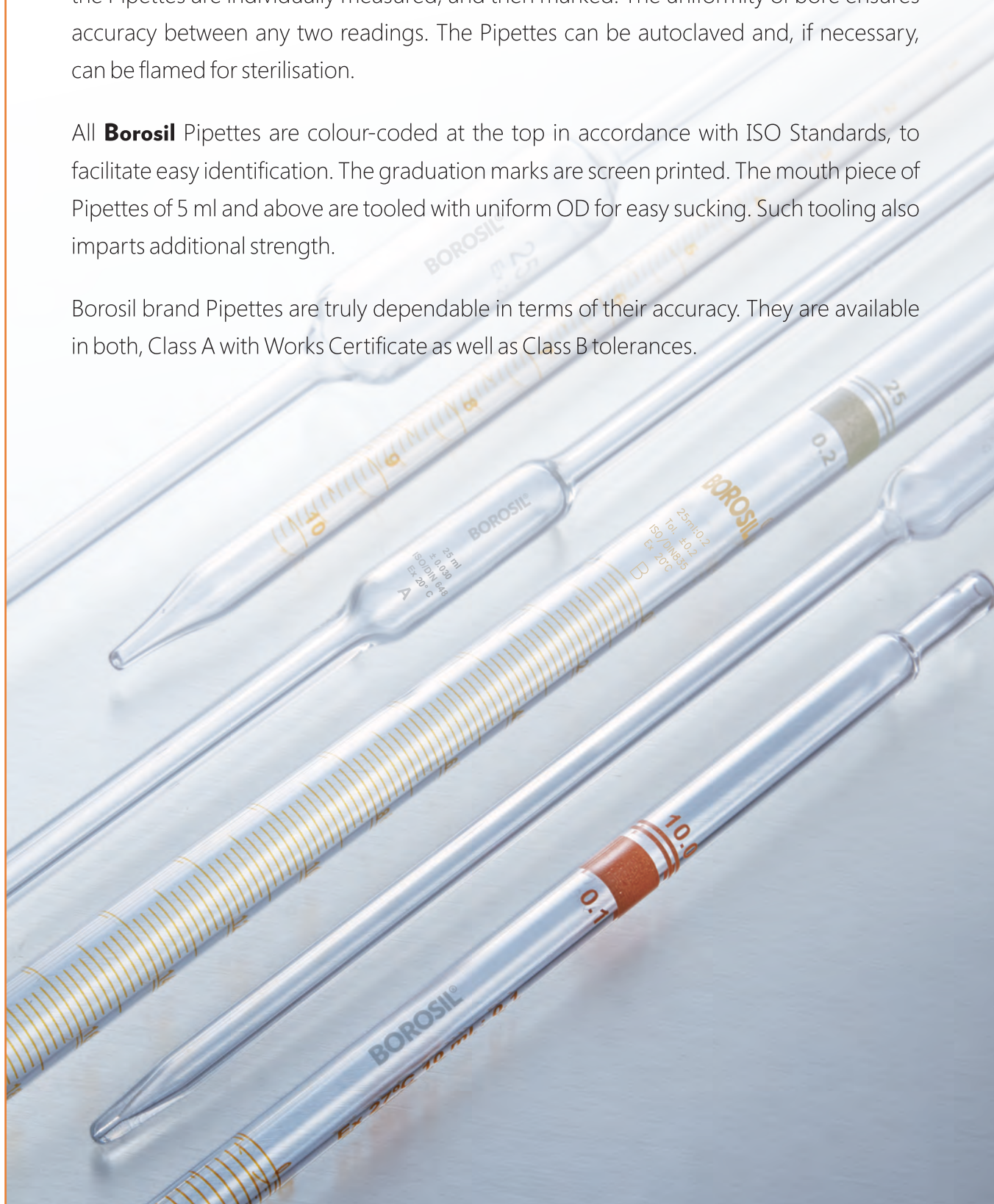



**Manufacturer**

**Nominal Capacity**

25 ml

**Tolerance**

± 0.030

**Standards**

ISO/DIN 648

**Ref Temperature**

Ex 20° C

**Calibration**  
(Ex = to deliver)

A

**Class A certified**



Tips are carefully tooled and ensure proper flow rates

Tip edges are fire polished



All pipettes are colour coded at the top to allow fast identification



Mohr Type  
Delivery from zero mark to the last graduation mark



Serological Type  
Delivery from zero mark to the tip

**Two Rings**

Two rings at the top indicate that these pipettes are calibrated to deliver their total capacity

**Pipettes**



### 7059 - Pipettes, Measuring (Mohr Type), Class A, with Batch Certificate

- Complies with IS, EN ISO 835
- These Pipettes are graduated for delivery from zero mark to the last graduation mark
- Sturdy, designed to last long
- Markings are made in permanent amber stain diffused into the surface of the glass for better visibility and durability
- Supplied with individual calibration certificate showing actual volume dispensed and providing traceability to national standards

Product Code	Capacity ml	Graduation Interval ml	Tolerance $\pm$ ml	Quantity per Case
7059P41A	0.1	0.01	0.006	10
7059P42A	0.2	0.01	0.006	10
7059P01A	1	0.01	0.007	10
7059P11A	1	0.10	0.007	10
7059P02A	2	0.02	0.01	10
7059P22A	2	0.10	0.01	10
7059P05A	5	0.05	0.03	10
7059P55A	5	0.10	0.03	10
7059P06A	10	0.10	0.05	10
7059P09A	25	0.20	0.10	10

\* Blue graduations can be supplied on request.

\* Individual calibration certificate can be provided on request.

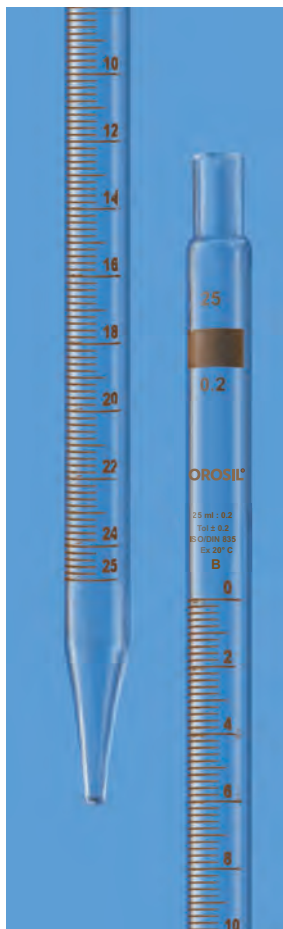

### 7060 - Pipettes, Measuring (Mohr Type), Class B

- Complies to IS, EN ISO 835
- These Pipettes are graduated for delivery from zero mark to the last graduation mark
- Sturdy, designed to last long
- Markings are made in permanent amber stain diffused into the surface of the glass for better visibility and durability

Product Code	Capacity ml	Graduation Interval ml	Tolerance $\pm$ ml	Quantity per Case
7060P41D	0.1	0.01	0.01	20
7060P42D	0.2	0.01	0.01	20
7060P01D	1	0.01	0.01	20
7060P11D	1	0.10	0.01	20
7060P02D	2	0.02	0.02	20
7060P22D	2	0.10	0.02	20
7060P05D	5	0.05	0.05	20
7060P55D	5	0.10	0.05	20
7060P06D	10	0.10	0.10	20
7060P09D	25	0.20	0.20	20

\* Blue graduations can be supplied on request.

## 7062 - Pipettes, Measuring (Mohr Type), Class B, White Marking

- Complies with EN ISO 835
- These Pipettes are graduated for delivery from zero mark to the last graduation mark
- Sturdy, designed to last long
- Markings are made in permanent amber stain diffused into the surface of the glass for better visibility and durability

Product Code	Capacity ml	Graduation Interval ml	Tolerance $\pm$ ml	Quantity per Case
7062P41D	0.1	0.01	0.01	20
7062P42D	0.2	0.01	0.01	20
7062P01D	1	0.01	0.01	20
7062P11D	1	0.10	0.01	20
7062P02D	2	0.02	0.02	20
7062P22D	2	0.10	0.02	20
7062P05D	5	0.05	0.05	20
7062P55D	5	0.10	0.05	20
7062P06D	10	0.10	0.10	20
7062P09D	25	0.20	0.20	20

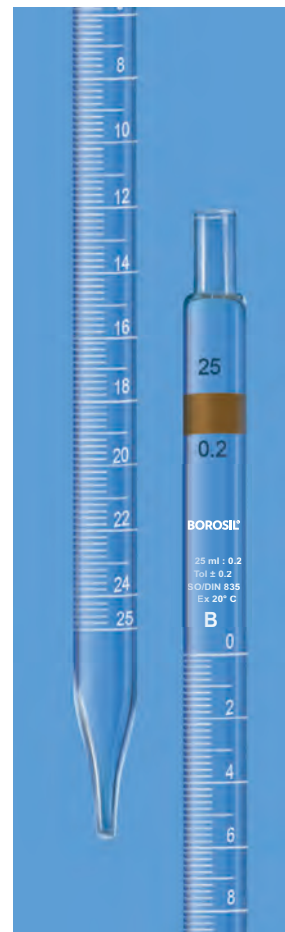

**NABL  
CERTIFIED**

## 2031 - Pipettes, Measuring (Mohr Type), Accuracy as per Class A, with Certificate, ISO 835, NABL Certified

- Complies with IS, EN ISO 835
- These Pipettes are graduated for delivery from zero mark to the last graduation mark
- Sturdy, designed to last long
- Markings are made in permanent amber stain diffused into the surface of the glass for better visibility and durability
- Supplied with individual NABL calibration certificate showing actual volume dispensed and providing traceability to national standards

Product Code	Capacity ml	Graduation Interval ml	Tolerance $\pm$ ml	Quantity per Case
2031P01	1	0.01	0.007	10
2031P02	2	0.02	0.01	10
2031P05	5	0.05	0.03	10
2031P06	10	0.1	0.05	10
2031P09	25	0.2	0.1	10
2031P11	1	0.1	0.007	10
2031P22	2	0.1	0.01	10
2031P41	0.1	0.01	0.06	10
2031P42	0.2	0.01	0.006	10
2031P55	5	0.1	0.03	10



**Pipettes**

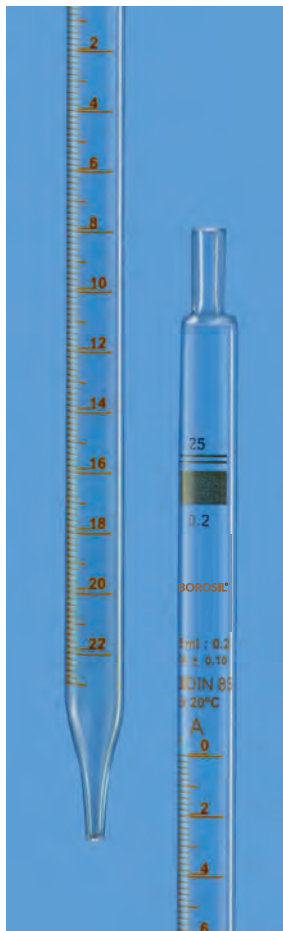

### 7079 - Pipettes, Serological, Class A, with Batch Certificate

- Complies with IS, EN ISO 835
- These Pipettes are graduated to the tip
- Two rings at the top indicate that the Pipette is calibrated to deliver from any graduation line down to tip
- Markings are made in permanent amber stain diffused into the surface of the glass for better visibility and durability

Product Code	Capacity ml	Graduation Interval ml	Tolerance ±ml	Quantity per Case
7079P41A	0.1	0.01	0.006	10
7079P42A	0.2	0.01	0.006	10
7079P01A	1	0.01	0.007	10
7079P11A	1	0.10	0.007	10
7079P02A	2	0.02	0.01	10
7079P22A	2	0.10	0.01	10
7079P05A	5	0.05	0.03	10
7079P55A	5	0.10	0.03	10
7079P06A	10	0.10	0.05	10
7079P09A	25	0.20	0.10	10

\* Blue graduations can be supplied on request.

\* Individual calibration certificate can be provided on request

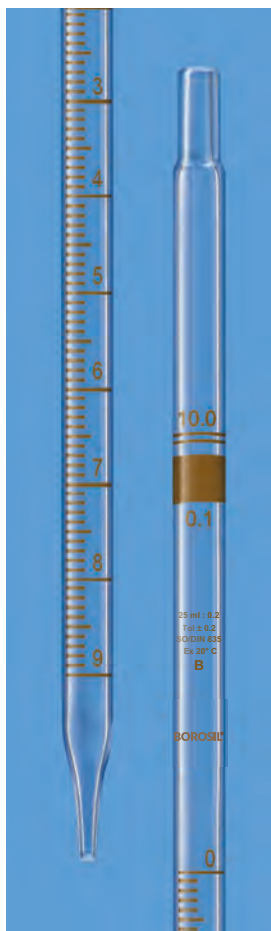

### 7080 - Pipettes, Serological Class B

- Complies with IS, EN ISO 835
- These Pipettes are graduated to the tip
- Two rings at the top indicate that the Pipette is calibrated to deliver from any graduation line down to tip
- Markings are made in permanent amber stain diffused into the surface of the glass for better visibility and durability

Product Code	Capacity ml	Graduation Interval ml	Tolerance ±ml	Quantity per Case
7080P41D	0.1	0.01	0.01	20
7080P42D	0.2	0.01	0.01	20
7080P01D	1	0.01	0.01	20
7080P11D	1	0.10	0.01	20
7080P02D	2	0.02	0.02	20
7080P22D	2	0.10	0.02	20
7080P05D	5	0.05	0.05	20
7080P55D	5	0.10	0.05	20
7080P06D	10	0.10	0.10	20
7080P09D	25	0.20	0.20	20



## 7081 - Pipettes, Serological, Class A Accuracy as per USP with Batch Certificate

- Complies with ASTM 1293 - 02
- These Pipettes are graduated for delivery from zero mark to the last graduation mark
- Sturdy, designed to last long
- Markings are made in permanent amber stain diffused into the surface of the glass for better visibility and durability
- Supplied with individual calibration certificate showing actual volume dispensed and providing traceability to national standards

Product Code	Capacity ml	Graduation Interval ml	Tolerance $\pm$ ml	Quantity per Case
7081P01A	1	0.01	0.01	10
7081P11A	1	0.1	0.01	10
7081P22A	2	0.1	0.01	10
7081P55A	5	0.1	0.02	10
7081P06A	10	0.1	0.03	10
7081P09A	25	0.1	0.05	10

\* Individual calibration certificate can be provided on request



## 7082 - Pipettes, Serological, (White Marking), Class B

- Complies with IS, EN ISO 835
- These Pipettes are graduated to the tip
- Two rings at the top indicate that the Pipette is calibrated to deliver from any graduation line down to tip
- Graduation in white enamel increases the visibility with dark solution

Product Code	Capacity ml	Graduation Interval ml	Tolerance $\pm$ ml	Quantity per Case
7082P41D	0.1	0.01	0.01	20
7082P42D	0.2	0.01	0.01	20
7082P01D	1	0.01	0.01	20
7082P11D	1	0.10	0.01	20
7082P02D	2	0.02	0.02	20
7082P22D	2	0.10	0.02	20
7082P05D	5	0.05	0.05	20
7082P55D	5	0.10	0.05	20
7082P06D	10	0.10	0.10	20
7082P09D	25	0.20	0.20	20

\* Blue graduations can be supplied on request.

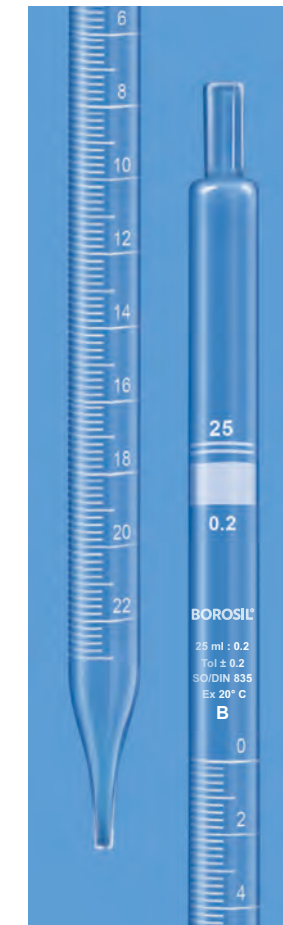

Pipettes

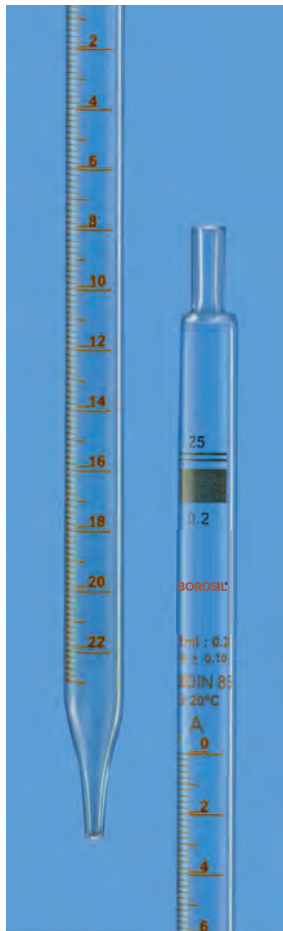

**NABL  
CERTIFIED**

**2032 - Pipettes, Measuring (Serological Type), Accuracy as per Class A, with Certificate, ASTM 1293-02, NABL Certified**

Product Code	Capacity ml	Graduation Interval ml	Tolerance $\pm$ ml	Quantity per Case
2032P01	1	0.01	0.01	10
2032P06	10	0.1	0.3	10
2032P09	25	0.1	0.5	10
2032P011	1	0.1	0.01	10
2032P022	2	0.1	0.01	10
2032P055	5	0.1	0.02	10



Pipettes



**7100 - Pipettes, Transfer, Volumetric, Class A Accuracy, with Batch Certificate**

- Complies with EN ISO 648
- Calibrated for delivery (TD, Ex)
- Generally used for accurate measurement and decanting of liquid
- Each pipette coded with unique no. supplied with calibration certificate giving exact volume with traceability to national standards

Product Code	Capacity ml	Tolerance $\pm$ ml	Quantity per Case
7100001A	1	0.008	10
7100002A	2	0.010	10
7100005A	5	0.015	10
7100006A	10	0.02	10
7100008A	20	0.03	10
7100009A	25	0.03	10
7100012A	50	0.05	10
7100016A	100	0.08	10



\* Individual calibration certificate can be provided on request.

## 7101 - Pipettes, Transfer, Volumetric, Class A, Accuracy as per USP With Batch Certificate

- Complies with ASTM E-969-02
- Calibrated for delivery (TD, Ex)
- Generally used for accurate measurement and decanting of liquid
- Each pipette coded with unique no. supplied with calibration certificate giving exact volume with traceability to national standards

Product Code	Capacity ml	Tolerance $\pm$ ml	Quantity per Case
7101001A	1	0.006	10
<b>NEW</b> 7101105A	1.5*	0.006	10
7101002A	2	0.006	10
<b>NEW</b> 7101205A	2.5*	0.01	10
7101003A	3	0.01	10
7101004A	4	0.01	10
7101005A	5	0.01	10
7101706A	6	0.01	10
7101707A	7	0.01	10
7101708A	8	0.02	10
7101709A	9	0.02	10
7101006A	10	0.02	10
7101007A	15	0.03	10
7101008A	20	0.03	10
7101009A	25	0.03	10
7101010A	30	0.03	10
7101011A	40	0.05	10
7101012A	50	0.05	10
7101016A	100	0.08	10

-\*Not covered in standards

\* Individual calibration certificate can be provided on request.



**NABL**  
CERTIFIED

## 2041 - Pipettes, Transfer, Volumetric, Class A, ASTM E-969-02, NABL Certified

Product Code	Capacity ml	Tolerance $\pm$ ml	Quantity per Case
2041001	1	0.006	10
2041002	2	0.006	10
2041003	3	0.01	10
2041004	4	0.01	10
2041005	5	0.01	10
2041006	6	0.01	10
2041007	7	0.01	10
2041008	8	0.02	10
2041009	9	0.02	10
2041006	10	0.02	10
2041007	15	0.03	10
2041008	20	0.03	10
2041011	40	0.05	10
2041012	50	0.058	10



Pipettes



### 7102 - Pipettes, Transfer, Volumetric, Class B

- Complies with EN ISO 648
- Calibrated for delivery
- Generally used for accurate measurement and decanting of liquid

Product Code	Capacity ml	Tolerance ± ml	Quantity per Case
7102001D	1	0.015	10
7102002D	2	0.02	10
7102005D	5	0.03	10
7102006D	10	0.04	10
7102008D	20	0.06	10
7102009D	25	0.06	10
7102012D	50	0.10	10
7102016D	100	0.15	10



### 7103 - Pipettes, Transfer, Volumetric, Class B

- Complies with ASTM E-969-02
- Calibrated for delivery
- Generally used for accurate measurement and decanting of liquid

Product Code	Capacity ml	Tolerance ± ml	Quantity per Case
7103001D	1	0.012	10
7103002D	2	0.012	10
7103003D	3	0.02	10
7103004D	4	0.02	10
7103005D	5	0.02	10
7103706D	6	0.03	10
7103707D	7	0.03	10
7103708D	8	0.04	10
7103709D	9	0.04	10
7103006D	10	0.04	10
7103007D	15	0.06	10
7103008D	20	0.06	10
7103009D	25	0.06	10
7103010D	30*	0.06	10
7103011D	40*	0.10	10
7103012D	50	0.10	10
7103016D	100	0.16	10

\* Not covered in ASTM standards

## 7105 - Pipette, Ostwald - Folin

- Complies with IS 5155 : 2009

Product Code	Capacity ml	Quantity per Case
7105P45	0.5	10
7105001	1	10

These pipettes are generally used for blood serum tests. They are calibrated to deliver by blowing out the last drop.

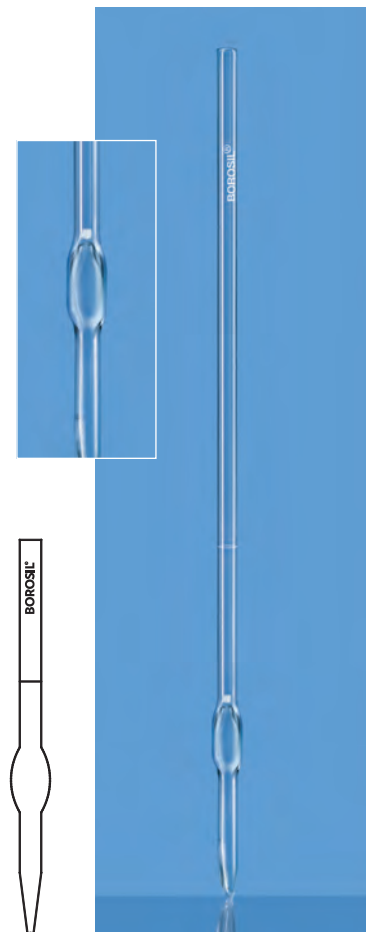

## 7106 - Pipettes, Transfer, Volumetric, Class A, Accuracy as per USP, Amber with Batch Certificate

- Complies with ASTM E-969-02
- Calibrated for delivery (TD, Ex)
- Generally used for accurate measurement and decanting of liquid
- Each pipette coded with unique no. supplied with calibration certificate giving exact volume with traceability to national standards

Product Code	Capacity ml	Tolerance $\pm$ ml	Quantity per Case
7106001A	1	0.006	10
7106002A	2	0.006	10
7106005A	5	0.010	10
7106006A	10	0.02	10
7106008A	20	0.03	10
7106009A	25	0.03	10
7106012A	50	0.05	10
7106016A	100	0.08	10

\* Individual calibration certificate can be provided on request



Pipettes

# Weighing Scoop

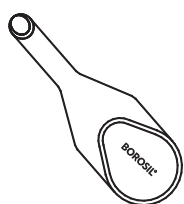

Borosil Weighing Scoops are primarily used when small quantities of powder, liquid or semi-solid material need to be weighed. The powder can be introduced into the receiving vessel through the tubular stem.

## 7200 – Weighing Scoop

- Weighing Scoops have an open tubular arm.
- Ideal for weighing small quantities of dyes and powders

Product Code	Capacity ml	Quantity per Case
7200001	1	10
7200002	2	10
7200003	3	10
7200076	6	10
7200006	10	10

# Tubes

Based on your needs, we offer an assortment of centrifuge tubes, Folin-Wu Tubes. All are made from uniformly drawn high quality tubing for extended service life and your safety.

## 7840 - Tubes, Blood Sugar, Folin-Wu

- Complies with IS 3740
- Made of uniformly drawn high quality tubing for extended service life
- The tube is calibrated at 12.5 ml and 25 ml

Product Code	Capacity ml	Approx O.D. x Length mm	Quantity Per Case
7840009	25	20 x 220	20



Weighing Scoop

### 7920 - Tubes, Digestion, Folin - Wu

- Made from uniformly drawn high quality tubing for extended service life
- The tube is calibrated at 35 ml and 50 ml

Product Code	Approx O.D. x Length mm	Quantity Per Case
7920057	25 x 200	20



### 8060 - Tubes, Centrifuge, Conical Bottom Plain

- Made of uniformly drawn high quality tubing for extended service life
- The higher density fraction collects in the pointed centre of the base
- Consequently, even small amounts of solids can be collected and separated

Product Code	Capacity ml	Approx O.D. x Length mm	Quantity Per Case
8060007	15	17 x 120	100



### 8080 - Tubes, Centrifuge, Conical Bottom, Graduated

- Made of uniformly drawn high quality tubing for extended service life
- The higher density fraction collects in the pointed centre of the base
- Consequently, even small amounts of solids can be collected and separated
- Graduated for greater precision

Product Code	Capacity ml	Approx O.D. x Length mm	Quantity Per Case
8080007	15	17 x 120	30
8080012	50	29 x 140	20



Tubes



### 8084 - Tubes, Centrifuge, Conical Bottom, Graduated, with Stopper

- Made of uniformly drawn high quality tubing for extended service life
- The higher density fraction collects in the pointed centre of the base
- Consequently, even small amounts of solids can be collected and separated
- Graduated tubes for greater precision
- Equipped with a stopper

Product Code	Capacity ml	Approx O.D. x Length mm	Quantity Per Case
8084007	15	17 x 139	30
8084012	50	29 x 165	10

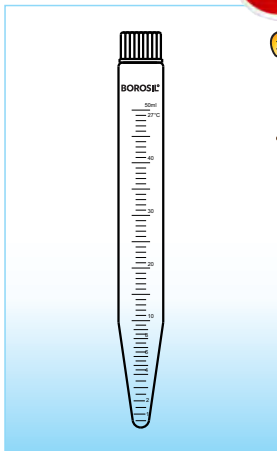

### 8090 - Tubes centrifuge conical bottom, graduated, with PP screw cap

Product Code	Capacity ml	Approx O.D. x Length mm	Quantity Per Case
8090007	15	17 x 130	30
8090012	50	29 x 150	10

Tubes



### 8100 - Stoppers, Interchangeable Ground Joint, Solid, Penny Head

Product Code	Interchangeable Joint	Quantity Per Case
8100007D	7 / 16	100
8100A10D	10 / 19	100
8100A12D	12 / 21	100
8100A14D	14 / 23	100
8100A19D	19 / 26	100
8100A24D	24 / 29	100
8100A24D	29 / 32	100



## 8320 - Tubes, Centrifuge, Short Conical Bottom, Pour Out, Heavy Duty, Plain

- Made of uniformly drawn high quality tubing for extended service life
- The higher density fraction collects in the pointed centre of the base
- Consequently, even small amounts of solids can be collected and separated

Product Code	Capacity ml	Approx O.D. x Length mm	Quantity Per Case
8320011	40	29 x 116	20

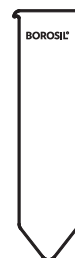

## 8340 - Tubes, Centrifuge, Short Conical Bottom, Pour Out, Heavy Duty, Graduated

- Made of uniformly drawn high quality tubing for extended service life
- The higher density fraction collects in the pointed centre of the base
- Consequently, even small amounts of solids can be collected and separated
- Graduated tubes for greater precision

Product Code	Capacity ml	Approx O.D. x Length mm	Quantity Per Case
8340011	40	29 x 116	20

Graduated upto 10 ml in 0.5 ml and from 10 ml to 40 ml in 1ml divisions

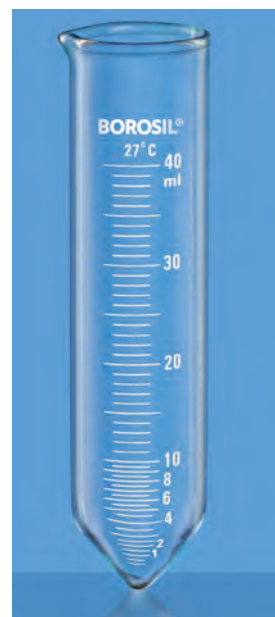

Tubes

## 8400 - Stoppers, Interchangeable Ground Joint, Solid, Penny Head, Amber

Product Code	Interchangeable Joint	Quantity Per Case
8400007D	7 / 16	100
8400A10D	10 / 19	100
8400A12D	12 / 21	100
8400A14D	14 / 23	100
8400A19D	19 / 26	100
8400A24D	24 / 29	100
8400A24D	29 / 32	100



# BOROSIL®

## Graduated Ware



- Range includes all types of Burettes, Pipettes, Cylinders, Volumetric Flasks
- Automated laser controlled Calibration
- Calibration as per ISO / DIN / ASTM standards
- Available as Class "A" and Class "B" accuracy levels
- In- house world class NABL (ISO/IEC: 17025, 2005) Accredited Calibration Laboratory

**Manufacturers of Laboratory Glassware**  
From 3.3 Low Expansion Borosilicate Glass

Did You Know?

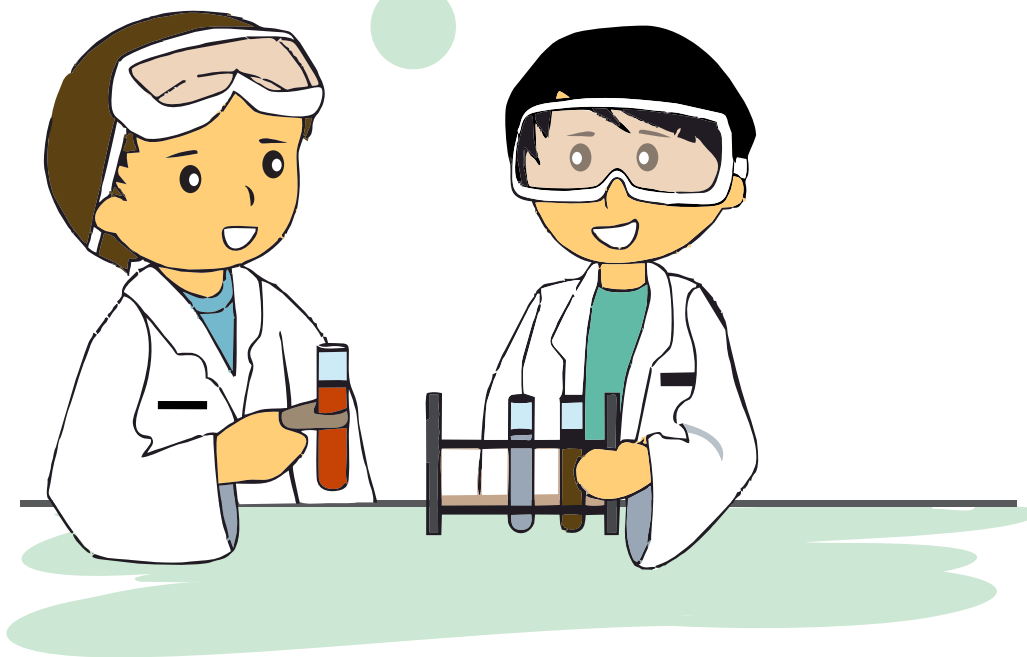

## Test Tube :

Before Michael Faraday invented the test tube in early 1800s chemists often used wine glasses for storage



**BOROSIL®**

- Adapters
- Test Tubes
- Sintered Ware
- Quartz Ware

# Adapters

The Adapter tubes listed below are the most widely used ones, and will enable a laboratory to assemble its own apparatus using the Flasks and Condensers listed earlier. The joints are fully interchangeable and made to the same precision as all Borosil ground joints.



## 8800 - Adapter, Enlarging, Interchangeable Joints

- Made of borosilicate glass
- An outer interchangeable joint at the top and a smaller inner interchangeable joint at the base
- These joints are made to the same precision as all Borosil ground joints

Product Code	Socket Joint Size	Cone Joint Size	Quantity Per Case
8800A01	19 / 26	14 / 23	5
8800A02	24 / 29	14 / 23	5
8800A03	24 / 29	19 / 26	5
8800A04	29 / 32	19 / 26	5
8800A05	29 / 32	24 / 29	5
8800A06	34 / 35	19 / 26	5
8800A07	34 / 35	24 / 29	5
8800A08	34 / 35	29 / 32	5



## 8820 - Adapter, Reduction, Interchangeable Joints

- Made of borosilicate glass
- An outer interchangeable joint at the top and a smaller inner inter-changeable joint at the base
- These joints are made to the same precision as all Borosil ground joints.

Product Code	Socket Joint Size	Cone Joint Size	Quantity Per Case
8820A09	29 / 32	34 / 35	5
8820A10	14 / 23	19 / 26	5
8820A11	14 / 23	24 / 29	5
8820A13	19 / 26	29 / 32	5
8820A14	19 / 26	34 / 35	5
8820A15	24 / 29	29 / 32	5
8820A16	24 / 29	34 / 35	5
8820A17	29 / 32	40 / 38	5
8820A18	19 / 26	24 / 29	5

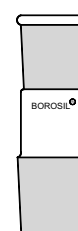

Adapters



### 8830 - Adapter, Receiver Bent With Vacuum Connection

Product Code	Socket Joint Size	Cone Joint Size	Quantity Per Case
8830614	14 / 23	14 / 23	5
8830619	19 / 26	19 / 26	5
8830719	19 / 26	24 / 29	5
8830624	24 / 29	24 / 29	5
8830724	24 / 29	29 / 32	5
8830629	29 / 32	29 / 32	5

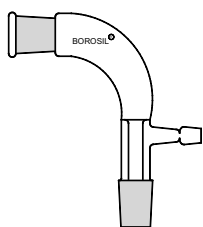

### 8831 - Adapter multiple with Two Neck Parallel

Product Code	Socket Joint Size	Cone Joint Size	Quantity Per Case
8831614	14 / 23	14 / 23	5
8831619	19 / 26	19 / 26	5
8831719	19 / 26	24 / 29	5
8831624	24 / 29	24 / 29	5
8831819	19 / 26	34 / 35	5
8831629	29 / 32	29 / 32	5

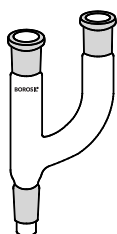

**8832-Adapter Multiple with Two Necks - one Vertical & one at 45°**

Product Code	Socket Joint Size	Cone Joint Size	Quantity Per Case
8832619	19 / 26	19 / 26	5
8832719	19 / 26	24 / 29	5
8832819	19 / 26	34 / 35	5

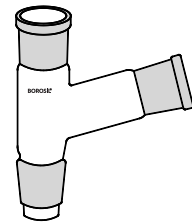

**8833 - Adapter Multiple with Three Neck, Two Parallel & one at 45°**

Product Code	Socket Joint Size	Cone Joint Size	Quantity Per Case
8833A19	19 / 26	24 / 29	5
8833B19	19 / 26	29 / 32	5
8833C19	19 / 26	34 / 35	5
8833D19	19 / 26	45 / 40	5

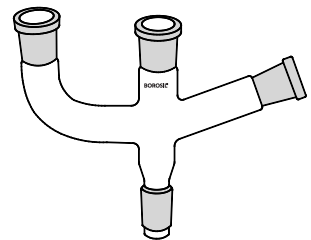



### 8834 - Swan Neck

Product Code	Socket Joint Size	Cone Joint Size	Quantity Per Case
8834619	19 / 26	19 / 26	5
8834719	19 / 26	24 / 29	5
8834624	24 / 29	24 / 29	5
8834724	24 / 29	34 / 35	5

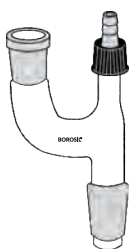

### 8835 - Adapter Cone / Rubber Tubing

Product Code	Socket Joint Size	Quantity Per Case
8835A10	10 / 19	5
8835A14	14 / 23	5
8835A19	19 / 26	5
8835A24	24 / 29	5
8835A29	29 / 32	5

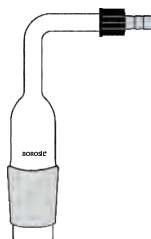



### 8836 - Adapter Cone / Flexible Tubing

Product Code	Socket Joint Size	Quantity Per Case
8836A14	14 / 23	5
8836A19	19 / 26	5
8836A24	24 / 29	5
8836A29	29 / 32	5
8836B10	10 / 19	5
8836B14	14 / 23	5
8836B19	19 / 26	5
8836B24	24 / 29	5
8836B29	29 / 32	5

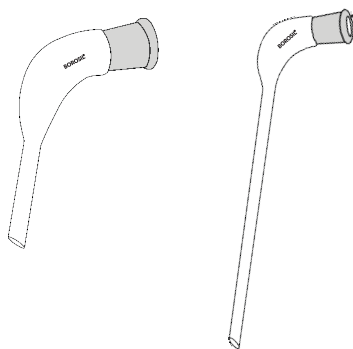

### 8837- Adapter Receiver Straight Socket To Rubber

Product Code	Socket Joint Size	Quantity Per Case
8837A14	14 / 23	5
8837A19	19 / 26	5
8837A24	24 / 29	5
8837A34	34 / 35	5



Adapters



### 8838 - Adapter Receiver Straight With Vacuum

Product Code	Socket Joint Size	Cone Joint Size	Quantity Per Case
8838614	14 / 23	14 / 23	5
8838714	14 / 23	19 / 26	5
8838814	14 / 23	24 / 29	5
8838619	19 / 26	19 / 26	5
8838719	19 / 26	24 / 29	5
8838624	24 / 29	24 / 29	5
8838724	24 / 29	29 / 32	5

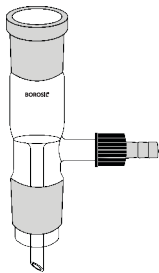

### 8839 - Adapter Receiver Bend With Vent

Product Code	Socket Joint Size	Cone Joint Size	Quantity Per Case
8839614	14 / 23	14 / 23	5
8839619	19 / 26	19 / 26	5
8839719	19 / 26	24 / 29	5
8839624	24 / 29	24 / 29	5
8839629	29 / 32	29 / 32	5

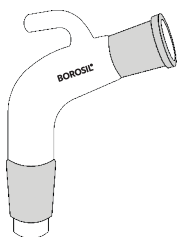

### 8840 - Adapter Cones Screw Thread

Product Code	Socket Joint Size	Quantity Per Case
8840A14	14 / 23	5
8840A19	19 / 26	5
8840A24	24 / 29	5
8840A29	29 / 32	5



### 8841 - Slopping Plane Still Head

Product Code	Flask Cone	Cond. Cone	Socket	Quantity Per Case
8841610	10 / 19	10 / 19	10 / 19	5
8841614	14 / 23	14 / 23	14 / 23	5
8841619	19 / 26	19 / 26	14 / 23	5
8841819	19 / 26	19 / 26	19 / 26	5
8841724	24 / 29	19 / 26	14 / 23	5
8841624	24 / 29	24 / 29	19 / 26	5
8841729	29 / 32	19 / 26	14 / 23	5
8841629	29 / 32	29 / 32	14 / 23	5
8841634	34 / 35	19 / 26	14 / 23	5
8841734	34 / 35	24 / 29	14 / 23	5
8841834	34 / 35	34 / 35	14 / 23	5

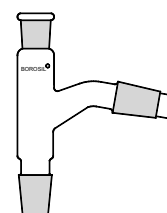

Adapters



### 8844 - Adapter Receiver Multiple Connectivity

Product Code	Socket Joint Size	Cone Joint Size	Quantity Per Case
8844614	14 / 23	14 / 23	5
8844714	14 / 23	19 / 26	5
8844619	19 / 26	19 / 26	5

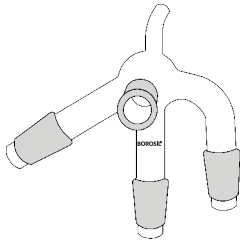

### 8845 - Adapter Receiver Plain Bend

Product Code	Socket Joint Size	Cone Joint Size	Quantity Per Case
8845619	19 / 26	19 / 26	5
8845719	19 / 26	24 / 29	5
8845624	24 / 29	24 / 29	5
8845629	29 / 32	29 / 32	5

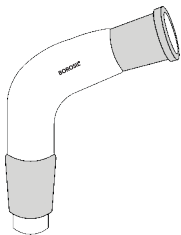

### 8846 - Adapter recovery bend with sloping end

Product Code	Socket Joint Size	Cone Joint Size	Quantity Per Case
8846614	14 / 23	14 / 23	5
8846724	24 / 29	14 / 23	5
8846619	19 / 26	19 / 26	5
8846824	24 / 29	19 / 26	5
8846729	29 / 32	19 / 26	5
8846734	34 / 35	19 / 26	5
8846624	24 / 29	24 / 29	5
8846834	34 / 35	24 / 29	5
8846634	34 / 35	34 / 35	5

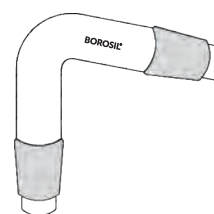

### 8847 - Adapter Recovery Bend Vertical

Product Code	Socket Joint Size	Cone Joint Size	Quantity Per Case
8847614	14 / 23	14 / 23	5
8847619	19 / 26	19 / 26	5
8847724	24 / 29	14 / 23	5
8847624	24 / 29	24 / 29	5
8847629	29 / 32	29 / 32	5

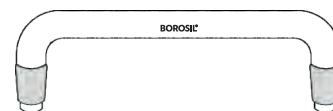
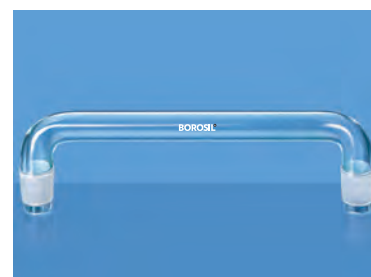

Adapters



### 8849 - Claisen Head Sloping

Product Code	Socket Joint Size	Cone Joint Size	Quantity Per Case
8849614	14 / 23	14 / 23	5
8849619	19 / 26	19 / 26	5
8849724	24 / 29	19 / 26	5
8849624	24 / 29	24 / 29	5
8849629	29 / 32	29 / 32	5
8849734	34 / 35	24 / 29	5

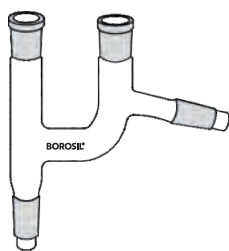

### 8850 - Adapter Receiver Plain, Vertical

Product Code	Socket Joint Size	Cone Joint Size	Quantity Per Case
8850614	14 / 23	14 / 23	5
8850719	19 / 26	24 / 29	5
8830724	24 / 29	29 / 32	5

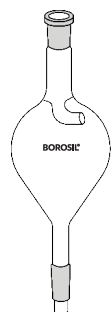

### 8851 - Splash head Vertical Pear Shape

Product Code	Socket Joint Size	Cone Joint Size	Quantity Per Case
8851619	19 / 26	19 / 26	5
8851724	24 / 29	19 / 26	5
8851624	24 / 29	24 / 29	5
8851629	29 / 32	29 / 32	5

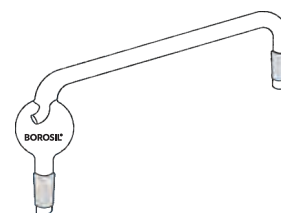

### 8852 - Splash Head Sloping Pear Shape

Product Code	Socket Joint Size	Cone Joint Size	Quantity Per Case	
8852619	19 / 26	19 / 26	5	
8852724	24 / 29	19 / 26	5	
8852624	24 / 29	24 / 29	5	
8852629	29 / 32	29 / 32	5	

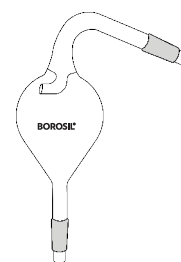

### 8853 - Steam distillation Heads

Product Code	Socket Joint Size	Cone Joint Size	Quantity Per Case
8853724	24 / 29	19 / 26	5
8853734	34 / 35	19 / 26	5
8853834	34 / 35	24 / 29	5

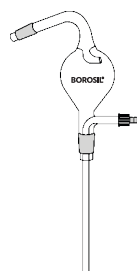

Adapters



### 9800 - Tubes, Test, With Rim

- Complies with IS 2618, ISO / DIN 4142
- Made of borosilicate glass, designed with a round bottom
- Made thick-walled, mechanically very resistant
- High thermal shock resistance
- Designed with a rim

Product Code	Capacity ml	Approx O.D. x Length mm	Quantity Per Case
9800U01	3	10 x 75	800
9800U02	5	12 x 75	800
9800U03	7	12 x 100	800
9800U15	4	13 x 55*	800
9800U04	13	15 x 125	800
9800U05	15	15 x 150	800
9800U06	27	18 x 150	400
9800U07	38	25 x 100	200
9800U08	55	25 x 150	200
9800U09	70	25 x 200	100
9800U10	100	32 x 200	50
9800U11	170	38 x 200	50

\* IS : 3740 for tube widal

Customized size can be provided on request

Test Tubes

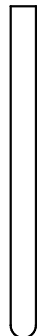
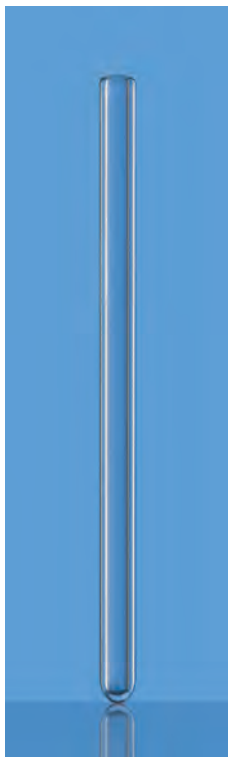

### 9801 - Tube for Culture collection

- Made of borosilicate glass, designed with a round bottom
- Made thick-walled, mechanically very resistant
- High thermal shock resistance
- Used for pathological tests

Product Code	Approx O.D. x Length mm	Quantity Per Case
9801U01	7 x 127	200

Used for pathological tests



### 9820 - Tubes, Test (Culture), Without Rim

- Complies with IS 2618, ISO / DIN 4142
- Made of borosilicate glass, designed with a round bottom
- Made thick-walled, mechanically very resistant
- High thermal shock resistance
- Designed without a rim

Product Code	Capacity ml	Approx O.D. x Length mm	Quantity Per Case
9820U16	1	7 x 60*	400
9820U01	3	10 x 75***	800
9820U02	5	12 x 75**/***	800
9820U03	7	12 x 100***	800
9820U17	8	12 x 125***	800
9820U04	13	15 x 125	800
9820U05	15	15 x 150	400
9820U12	12	16 x 100***	800
9820U18	20	16 x 150***	400
9820U06	27	18 x 150	400
9820U19	25	19 x 125***	400
9820U07	38	25 x 100	200
9820U08	55	25 x 150***	200
9820U09	70	25 x 200	100
9820U10	100	32 x 200	50
9820U11	170	38 x 200	50

\* IS:3740 - 1966 for DURHAM FERMENTATION

\*\* IS:3740 - 1966 for KAHN & WASSERMAN TEST

\*\*\* IS:3740 - 1966 for BACTERIOLOGICAL TEST

Customized size can be provided on request

### 9821 - Tube Flat Bottom without RIM

- Made of borosilicate glass, designed with a flat bottom
- High thermal shock resistance
- Designed without a rim
- Used for pathological tests and disintegration apparatus

Product Code	Approx O.D. x Length mm	Quantity Per Case
9821U42	12 x 75	800



Test Tubes



### 9822 - Tube Flat Bottom with Rim

- Made of borosilicate glass, designed with a flat bottom
- High thermal shock resistance
- Designed with rim
- Used for pathological tests and disintegration apparatus

Product Code	Approx O.D. x Length mm	Quantity Per Case
9822U06	18 x 138	400
9822U07	18 x 55	100
9822U04	14 x 110	800

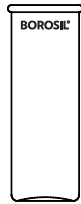

### 9830 - Tubes, Test Graduated, with interchangeable Stopper

- Made of borosilicate glass, designed with a round bottom
- Made thick-walled, mechanically very resistant
- High thermal shock resistance
- These Test Tubes are graduated for greater precision

Product Code	Capacity ml	Approx O.D. x Length mm	Stopper Size	Quantity Per Case
9830006	10	17 x 160	10 / 15	10
9830007	15	15 x 150	14 / 15	10
9830008	20	19 x 160	14 / 15	10
9830010	30	25 x 155	19 / 26	10
9830012	50	25 x 200	19 / 26	10
9830016	100	34 x 210	24 / 25	10



### 9835 - Tubes, COD Digestion Tube

- Made from thick walled, mechanically very resistance borosilicate glass
- Used in COD Disintegration

Product Code	Approx O.D. x Length mm	Quantity Per Case
9835A01	36 x 205	10
9835001	39 x 205	10

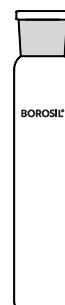

### 9850 - Stirrer

- Made of polished 3.3 borosilicate glass

Product Code	Approx O.D. x Length mm	Quantity Per Case
9850107	7 x 150	20
9850207	7 x 205	20
9850307	7 x 255	20
9850407	7 x 305	20
9850109	9 x 150	20
9850209	9 x 205	20
9850309	9 x 255	20
9850409	9 x 305	20

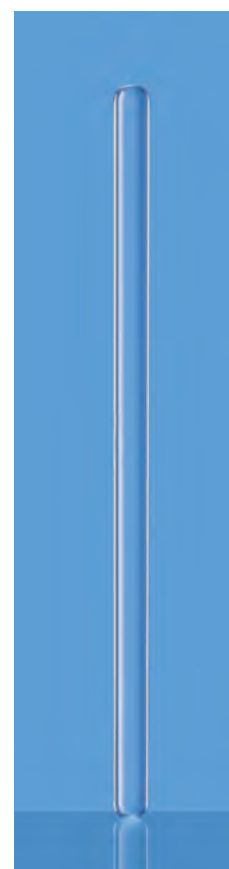

Test Tubes

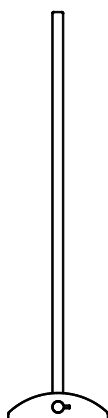
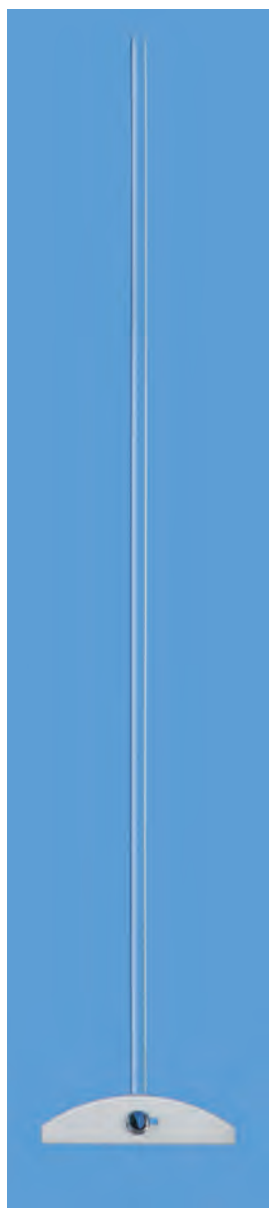

### 9860 - Stirrers, with PTFE Blade

- Ideal for very sensitive samples
- Made of polished 3.3 borosilicate glass
- Provided with chemically inert PTFE blade
- Application in synthetic laboratory

Product Code	Description	Quantity Per Case
9860065	Shaft Dia 6 mm & Length 450 mm Blade Width 50 mm, Suitable for 500 ml Flask, Socket 19 / 26	10
9860071	Shaft Dia 6 mm & Length 450 mm Blade Width 75 mm, Suitable for 1000 ml Flask, Socket 24 / 29	10
9860077	Shaft Dia 8 mm & Length 600 mm Blade Width 100 mm, Suitable for 2000 ml Flask, Socket 34 / 35	5
9860080	Shaft Dia 8 mm & Length 600 mm Blade Width 125 mm, Suitable for 5000 ml Flask, Socket 34 / 35	5
9860081	Shaft Dia 10 mm & Length 750 mm Blade Width 150 mm, Suitable for 10000 ml Flask, Socket 55 / 44	5
9860087	Shaft Dia 10 mm & Length 750 mm Blade Width 200 mm, Suitable for 20000 ml Flask, Socket 55 / 44	5

## 9900 - Tubes, Culture, Media, Round Bottom, with PP Screw Cap and Liner

- Made of borosilicate glass, designed with a round bottom
- The ideal replacement for media culture bottles
- Designed with special caps to facilitate handling and sealing
- The caps have a PTFE liner

Product Code	Capacity ml	Approx O.D. x Length mm	Quantity Per Case
9900005	5	16 x 75	100
9900006	10	16 x 125	100
9900010	30	25 x 100	100
9900012	50	25 x 150	50
9900013	60	25 x 200	50
9900018	150	38 x 200	50

Customized size can be provided on request



## 9901 - Tubes, Culture, Amber, Media, Round Bottom, with PP Screw Cap and PTFE Liner

- Made of borosilicate glass, designed with a round bottom
- The ideal replacement for media culture bottles
- The uniform Amber colour is highly durable and has high chemical resistance.
- Designed with special caps to facilitate handling and sealing
- The caps have a PTFE liner

Product Code	Capacity ml	Approx O.D. x Length mm	Quantity Per Case
9901005	5	16 x 75	100
9901006	10	16 x 125	100
9901010	30	25 x 100	100
9901013	60	25 x 200	50
9901018	150	38 x 200	50

Customized size can be provided on request



Test Tubes



### 9910 - Tubes, Culture, Media, Flat Bottom, with PP Screw Cap and PTFE Liner

- Made of borosilicate glass, designed with a flat bottom for convenient storage
- The ideal replacement for Bijou, Mc Cartney and universal bottles
- Designed with special caps to facilitate handling and sealing
- The caps have a PTFE liner

Product Code	Capacity ml	Approx O.D. x Length mm	Quantity Per Case
9910005	5	16 x 50	100
9910006	10	25 x 50	100
9910007	15	25 x 57	100
9910008	20	25 X 72	100
9910010	30	25 x 95	100
9910012	50	25 x 145	50

Customized size can be provided on request



### 9911 - Tubes, Culture, **Amber**, Media, Flat Bottom, with PP Screw Cap and PTFE Liner

- Made of borosilicate glass, designed with a flat bottom for convenient storage
- The ideal replacement for Bijou, Mc Cartney and universal bottles
- Designed with special caps to facilitate handling and sealing
- The **Amber** colour is applied to the external surface to prevent contamination with the testing material
- The caps have a PTFE liner

Product Code	Capacity ml	Approx O.D. x Length mm	Quantity Per Case
9911005	5	16 x 50	100
9911006	10	25 x 50	100
9911007	15	25 x 57	100
9911008	20	25 x 72	100
9911010	30	25 x 95	100

Customized size can be provided on request

# Watch Glasses

## 9986 - Watch Glasses, Borosil S - Line

- Made of soda glass
- A special process is used that results in an absolutely flat curved surface
- High clarity, free of bubbles
- All of them are moulded to the same radius of curvature for convenient stacking

Product Code	Capacity ml	Quantity Per Case
9986072	80	50
9986077	100	50
9986079	120	20
9986081	150	20

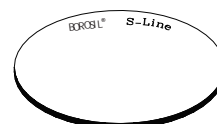
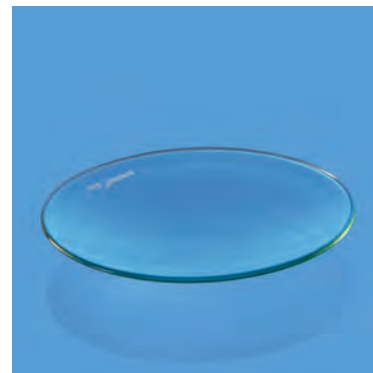

# Sintered Ware

## Technical Data

Borosil Sintered Glassware is used for filtration of liquids and gases in the laboratory. It has a non-corrosive and reusable porous glass disc as the filter media. It is also used for gas washing, dispersion and absorption.

The Sintered Disc is manufactured by crushing Borosil glass, and then powdering, cleaning and separating it into various mesh sizes, and finally, fusing it together in the form of a Disc. Sintered Discs are classified into 5 grades - G1, G2, G3, G4 and G5. The grades are defined in terms of the maximum pore size that is obtained by measuring the pressure at which the first air bubble breaks away from the filter, under specified conditions. The pressure differential is then used to calculate the equivalent capillary diameters in microns. The desired pore size is obtained by controlling the grain size, firing time, temperature and thickness of the Disc. Each Disc is tested and graded individually.

The pore diameters are reasonably uniform, which ensures the required flow rate through the filter. The flow rate further depends on the pressure differential between the two sides of the Disc, the free area of the Disc, viscosity of the fluid being filtered, and other factors. There is a fair amount of uniformity in the pore size of different Discs of the same size and grade. Hence, the results from two or more Discs of the same size and grade will be uniform, thereby ensuring reproducible analytical results.

The Discs have maximum surface hardness and hence, the glass powder does not get scraped off while cleaning or with chemicals. The filters do not shed particles during usage.

The Discs are sealed to tubing without blocking the pores. They are then annealed properly in automatically controlled Lehrs.

## Porosity Grades And Their General Use

Porosity Grade	Pore Size (Microns)	General use
1	90-150	Filtration of coarse materials / precipitates, gas dispersion, gas washing, extractor bed, support for other filter materials.
2	40-90	Filtration of medium precipitates gas dispersion, gas washing.
3	15-40	Filtration of fine grain precipitates. Analytical work with medium precipitates. Mercury filtration
4	5-15	Analytical work with fine and very fine precipitates. Non return mercury valves.
5	1-2	Bacteriological filtration.

## Chemical Durability

Borosil Sintered Ware is manufactured with the same high quality material of which all Borosil brand borosilicate laboratory glassware is made, ensuring excellent resistance to chemical attack.

## Operating Pressure

Sintered Discs, and the glassware that incorporates them, are designed mainly for the application of vacuum or for passage of gases at relatively low pressure. In all cases, the differential pressure must not exceed 100 kN / m<sup>2</sup> (15 psi).

## Thermal Limitations

Sintered Ware has a lower level of resistance to thermal shock as compared to standard Borosil glassware. Therefore, articles of Sintered Ware should not be subjected to excessive temperature changes or direct flames.

Borosil Sintered Crucibles are especially suitable for drying to constant weight. Dry Sintered Crucibles at room temperature, can be placed directly into a drying oven. Sintered Ware may safely be heated in a furnace to 500°C without any adverse effects, while ensuring that the cycle of heating and cooling is gradual. It is recommended that the rate of heating does not exceed 20°C/min. This prevents internal strains caused by excessive temperature differences between the surrounding glass vessel and the Sintered Disc that, in turn, can lead to fracture of the apparatus.

When cold and damp, Sintered Ware of porosity grades 4 and 5 should never be subjected to a sudden temperature change as the evolution of steam may generate pressure within the filter, sufficient to crack it.

Filtration Apparatus should be kept on its rim (stem upwards) in an oven or steriliser. A perforated support base is advantageous for air convection in case of pipeline filters. By using heat insulating material such as asbestos, care should be taken to avoid premature heating near the filter seal. The apparatus should remain in the oven or steriliser during cooling, to prevent excessively fast cooling.



## Cleaning Of Sintered Ware

New Sintered Filters should be washed carefully with hot hydrochloric acid, and then rinsed with distilled water before use. Such treatment ensures that all loose particles are removed from the Filter.

It is advisable to clean all Sintered Filters thoroughly, immediately after use, as cleaning is easiest at this time, and it also reduces the risk of contamination in the next use.

Many precipitates can be removed from the filter by back-flushing with water. However, great care must be taken with large diameters and fine filters, as positive pressures on the reverse side may break the filter.

Under no circumstances should Sintered Apparatus be subjected to mains water pressure when back-flushing, as in most instances this leads to fractured filters.

Drawing water through the filter from the reverse side, by means of a vacuum pump, is also effective.

Filters clogged with dust and dirt during gas filtration can be restored by treatment with warm detergent solution, followed by blowing clean air through, from the clean side of the filter. Dirt particles are brought to the surface by the foam, and removed by rinsing with water.

Some precipitates that clog the filter may be removed by chemical cleaning, as indicated below:

- **Fats and grease**  
Carbon tetrachloride or suitable organic solvent
- **Albumen glucose:**  
Hot ammonia or hydrochloric acid, mixture of hot concentrated sulphuric and nitric acids
- **Organic substances :**  
'Chromic' acid cleaning solution\* or concentrated sulphuric acid containing a little potassium nitrate or perchlorate (0.5%) (may need to be soaked overnight)
- **Copper or iron oxide :**  
Hot concentrated hydrochloric acid with potassium chlorate.
- **Barium sulphate :**  
Hot concentrated sulphuric acid
- **Mercury Residues :**  
Hot concentrate nitric acid
- **Mercury Sulphide :**  
Hot aqua regia
- **Silver chloride :**  
Ammonia or sodium hyposulphite
- **Stannic oxide :**  
Boiling sulphuric acid\*\*

### Alumina or silica residues :

2% hydrofluoric acid followed by concentrated sulphuric acid. Rinse immediately with distilled water and then with acetone. Continue rinsing until no trace of acid remains.

High concentrations of hydrofluoric acid, hot phosphoric acid or caustic alkali solutions should never be used for cleaning. Using these causes a rapid deterioration in the filter and an increase in pore size.

\* For bacteriological, pharmaceutical and biological work, 'chromic' acid cleaning solution should be avoided in view of the biological effect of chromium ions.

\*\* Boiling sulphuric acid may introduce undue thermal strain. It is therefore advisable to leave the item in the acid to cool.

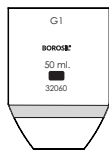

### 32060 - Crucible, Gooch Type, Low Form, with Sintered Disc

- Made of 3.3 borosilicate glass
- Particularly adapted to analytical work where precipitates are dried to constant weight at 110°C
- Crucibles should not be subjected to sudden temperature changes
- In order to avoid strain, they should not be removed from the furnace until the temperature has dropped to 250°C
- Gooch Crucible is used for metal casting and analysis

Product Code	Capacity ml	Porosity Grade mm	Dia of Disc mm	Approx Height	Quantity Per Case
3206007	15	1	20	50	10
3206607	15	2	20	50	10
3206707	15	3	20	50	10
3206807	15	4	20	50	10
3206907	15	5	20	50	10
3206010	30	1	30	60	10
3206610	30	2	30	60	10
3206710	30	3	30	60	10
3206810	30	4	30	60	10
3206910	30	5	30	60	10
3206012	50	1	40	65	10
3206612	50	2	40	65	10
3206712	50	3	40	65	10
3206812	50	4	40	65	10
3206912	50	5	40	65	10



### 32061 - Tubes, Filter, for Gooch Crucibles (Herarchi) Funnel

- Made of 3.3 borosilicate glass
- Suitable for use with Borosil's Filtering Crucibles Gooch type with Sintered Disc

Product Code	Approx O.D. x Length mm	Quantity Per Case
3206027	27 x 150	5
3206036	36 x 160	5
3206156	56 x 170	10

These are suitable for use with our filtering crucibles Gooch Type with sintered disc, No. 32060 lower part 8 mm O.D. x 75 mm length in all sizes.

### 36060 - Funnels, Buchner Type, with Sintered Disc

- Made of 3.3 borosilicate glass
- Especially useful where the filter paper may be attacked by filtered material
- Generally used in qualitative inorganic analysis and preparative chemistry
- Resistant to corrosion and heat

Product Code	Capacity ml	Porosity Grade	Dia of Disc mm	Approx Height mm	Stem Dia mm	Quantity Per Case
3606058	35	1	30	130	8	5
3606658	35	2	30	130	8	5
3606758	35	3	30	130	8	5
3606858	35	4	30	130	8	5
3606958	35	5	30	130	8	5
3606072	80	1	35	142	8	5
3606672	80	2	35	142	8	5
3606772	80	3	35	142	8	5
3606872	80	4	35	142	8	5
3606972	80	5	35	142	8	5
3606020	200	1	68	215	13	5
3606620	200	2	68	215	13	5
3606720	200	3	68	215	13	5
3606820	200	4	68	215	13	5
3606920	200	5	68	215	13	5
3606024	500	1	92	258	17	2
3606624	500	2	92	258	17	2
3606724	500	3	92	258	17	2
3606824	500	4	92	258	17	2
3606924	500	5	92	258	17	2
3606029	1000	1	124	276	19	2
3606629	1000	2	124	276	19	2
3606729	1000	3	124	276	19	2
3606829	1000	4	124	276	19	2
3606929	1000	5	124	276	19	2



Sintered Ware



### 39580 - Tubes, Sealed, With Reduced Ends, With Sintered Disc, (Pipeline Filters)

- Made of 3.3 borosilicate glass
- Generally used in inline filtration of gas lines to remove solid impurities

Product Code	Capacity ml	Porosity Grade	Dia of Disc mm	Approx Height mm	Stem Dia mm	Quantity Per Case
3958010	30	1	30	125	9	5
3958610	30	2	30	125	9	5
3958710	30	3	30	125	9	5
3958810	30	4	30	125	9	5
3958910	30	5	30	125	9	5
3958014	65	1	65	210	13	5
3958614	65	2	65	210	13	5
3958714	65	3	65	210	13	5
3958814	65	4	65	210	13	5
3958914	65	5	65	210	13	5
3958015	90	1	90	320	17	5
3958615	90	2	90	320	17	5
3958715	90	3	90	320	17	5
3958815	90	4	90	320	17	5
3958915	90	5	90	320	17	5

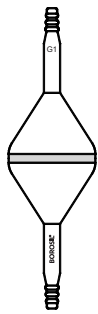

## Boron Free Transparent Silica

**Borosil** Fused Silica 99.95% SiO<sub>2</sub> surpasses all of the desirable chemical and weathering durability properties usually associated with opaque Silica ware. We manufacture as per IS and BS Standards.

- a) There is little or no visible surface change or damage to silica with prolonged exposure to water, atmospheric gases, contaminants, oxide of nitrogen and ozone.
- b) Attack does occur, on exposure to alkaline solution and acids at very high temperatures.
- c) Low expansion and hence excellent dimensional stability and thermal shock resistance.

### Resistant to chemical attack

Virtually unaffected by sulphuric, nitric and hydrochloric acids. Hot alkalies and certain metal oxides react on silica. It is attacked by hydrofluoric acid. At high temperatures, it is also attacked by phosphoric acid.

Continuous use of fused silica above 1000°C leads to devitrification with formation of cristobalite which is a crystalline phase and will lead to breakage on repeated use. For accurate and long use, it is advisable to wash the articles in distilled water and alcohol to remove trace impurities.

Heating fused quartz to elevated temperatures causes SiO<sub>2</sub> to undergo dissociation. Consequently, when flame-working fused quartz, there is a brand of haze or smoke which forms just outside the intensely heated region. This haze presumably forms because the SiO<sub>2</sub> recombines with oxygen from the air (and perhaps water) and condenses as extremely small particles of amorphous SiO<sub>2</sub>.

Co-efficient of expansion 0°C to 800°C	5.5 X 10 <sup>-7</sup> cm / cm / °C
Softening Point	1685°C
Annealing Point	1200°C
Strain Point	1120°C
Operating Temp	1050°C
Electrical resistivity (at 350°C)	7 x 10 <sup>7</sup> ohm cm

### 1002 - Beakers, Low Form, With Spout

- Beaker with Spout for Clean Pouring
- Dimensional accuracy
- Tough construction
- Durability

Product Code	Capacity ml	Approx O.D. x Length mm	Quantity Per Case
1002009	25	35 x 45	5
1002012	50	40 x 58	5
1002016	100	50 x 75	5
1002018	150	55 x 88	5
1002021	250	70 x 95	1
1002024	500	85 x 115	1
1002029	1000	105 x 145	1

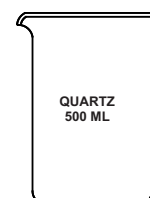



### 3175 - Muffle Trays

- Perfect finish
- Sturdiness
- Durability
- Holes: 2/4

Product Code	Capacity ml	Approx O.D. x Length mm	Quantity Per Case	Price / Piece ₹
3175041	2 Holes	39	1	1490.00
3175042	4 Holes	76	1	2920.00

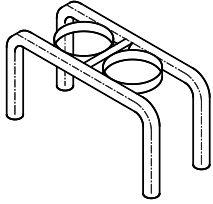

### 3185 - Dishes / Basins, Round with Spout

- Perfect finish
- Accurate dimensions
- Longer life span

Product Code	Approx O.D. x Height mm	Nominal Capacity ml	Quantity Per Case
3185008	55 x 23	20	10
3185042	75 x 27	45	5
3185044	85 x 35	70	5
3185045	95 x 36	85	1
3185016	100 x 38	100	1
3185046	115 x 47	200	1



### 3186 - Combustion Boats with Handle

- Light in weight
- Longer life span
- Accurate dimensions
- Sturdiness

Product Code	Approx O.D. x Length mm	Quantity Per Case
3186Q01	12 x 77	1

Prices for other sizes on request

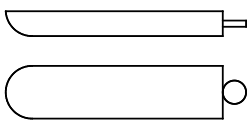

### 3190 - Crucibles, Without Lid

- Accurate dimensions
- Longer life span
- Fine finish
- Sturdiness

Product Code	Capacity ml	Approx O.D. x Length mm	Quantity Per Case
3190007	15	40 x 26	10
3190009	25	47 x 30	10
3190012	50	57 x 35	10
3190015	80	69 x 45	10
3190018	150	80 x 54	5

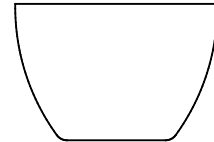

### 3191 - Lids For Crucibles

- Accurate dimension
- Longer life span
- Fine finish
- Sturdiness

Product Code	Capacity ml	Quantity Per Case
3191007	15	10
3191009	25	10
3191012	50	10
3191015	80	10

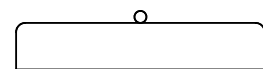

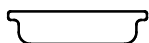
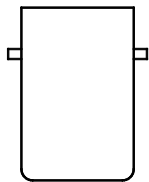
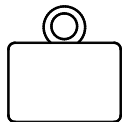

### Volatile Matter Crucibles

- Dimensional accuracy
- Tough construction
- Durability
- Comes with Lid and Plunger

Product Code	Catalogue No.	Item	Dimension mm	Quantity Per Case
3195041	3195	Crucible	25 x 38	5
3196041	3196	Plunger	12.5	5
3197041	3197	Lid		5



### 3198 - Silica Triangles on Nichrome (Translucent)

- Longer life span
- Sturdiness
- Seamless finish

Product Code	Capacity ml	Quantity Per Case
3198007	15	10
3198009	25	10
3198012	50	10
3198015	80	5

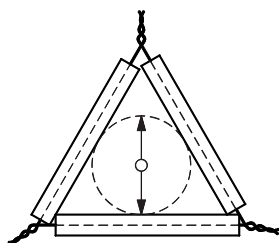



## 4984 - Quartz Conical Flask

- Suitable for digestion of samples with concentrated acid (except HF)
- Ideal for estimation of boron in soil
- Withstand sudden heating & cooling

Product Code	External Dimension		Capacity ml
	O.D. mm	Height mm	
4984016	64	105	100
4984018	72	124	150
4984021	85	140	250

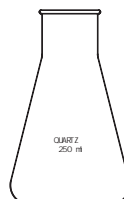

## 5644 - Flasks Volumetric, Quartz

- Dimensional accuracy
- Sturdiness
- Durability
- Perfect finish

Product Code	Capacity ml	Quantity Per Case
5644005	5	1
5644006	10	1
5644009	25	1
5644012	50	1
5644016	100	1
5644021	250	1
5644024	500	1
5644029	1000	1

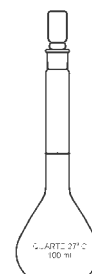
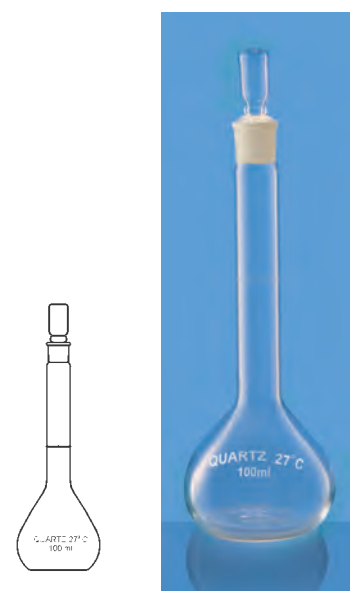

## 8600 - Quartz Circular Capsule for Coal Analysis

- Suitable for analysis of ash content in Coal analysis
- Withstand sudden heating & cooling

Product Code	External Dimension	
	Height mm	Diameter mm
8600Q01	14	48
8600Q02	15	54



\*The ash content in coal is an important parameter in determining the quality of coal. Ash reduces the calorific value of coals and hence burning coals on a large scale require knowledge of their ash content. Analysis is fairly straight forward, with the coal thoroughly burnt at 750°C to 800°C and the ash material express as a percentage of the original weight. It gives an indication about the quality of coal.

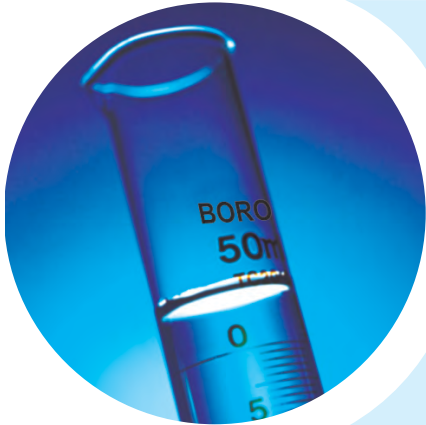

## ACCURACY

- Computer Controlled Calibration
- Reliability in experiments through individually certified volumetric glassware
- Facilitates audit procedures in the laboratory
- Enhanced production from new facility



## MECHANICAL STRENGTH

- Optimum wall thickness
- Annealed glassware imparts better mechanical strength
- Ideal for vacuum application, wet and dry sterilization
- Harder, hence lasts longer



## THERMAL SHOCK RESISTANCE

- Safely withstands thermal shock
- Annealed to remove residual thermal Stress
- Thinner, uniform wall, hence lasts longer



## CHEMICAL DURABILITY

- High resistance to attack from acids, salt solutions and organic solvents
- Low alkalinity, hence less leaching
- Low alkalinity makes glass harder, hence lasts longer

# Did You Know?

## Microscope slide

Before glass slides and coverslips, specimens were mounted using bone or mica.



**BOROSIL®**

- Chromatography Vials
- Microscope Slides & Cover Glasses
- Vetro Clean
- Lab Accessories

# BOROSIL®

## Analytical Vials & Closures

“for Labs where  
**compliance** matters”

Why should I choose BOROSIL vials?

No matter which make of instrument you use, it is critical that your sample is carried in a reliable vial.

Whereas, it is important that vials are made within stringent dimensions in controlled conditions to perform consistently, it is even more critical to a Chemist to be able to confidently rule out the vial as a contributor to an OOS (out of specification) incident.

BOROSIL being a manufacturer of vials, provides a Chemist access to the detailed testing & quality documentation of vials thereby enabling a chemist to investigate root causes effectively.



Borosil certified Vials are manufactured in an ISO 9001 certified facility, in accordance with US and European Pharmacopoeia.

*Easy ordering!!!*

## The 14 Digit Code

Whether you choose to buy a combipack that includes **Vials** and matching **Closures** or only the glass vial or only the vial closure, **BOROSIL's 14 digit code** makes it very easy in **FOUR** simple steps!

### STEP 1

#### Vial / Cap Size

1. Start from the middle. The vial mouth size (outer) or the closure size is specified in digits 7 & 8. **"09"** for 9mm vial, **"13"** for 13mm, **"20"** for 20mm etc.

### STEP 2

#### Combipack / Vial / Cap

The first TWO digits help you select how you want to buy,

1. A combipack of matching Vial & Closure, your product code will start with **"VC"**
2. Only a Vial, your product code will start with **"VO"**
3. Only a closure, your product code will start with **"CS"**

1	V	2	C	3	0	4	2	5	C	6	1	7	0	8	9	9	P	10	B	11	S	12	1	13	1	14	2
---	---	---	---	---	---	---	---	---	---	---	---	---	---	---	---	---	---	----	---	----	---	----	---	----	---	----	---

### STEP 3

When selecting a **Combipack** or just Vials, the Glass Component "Vial" specification is determined as,

1. 3rd & 4th digits of the code determines the volume of the vial you want to buy, i.e. **"02"** for a 2ml vial, **"04"** for a 4ml vial etc.
2. Digit 5, Choose the color of the glass, when buying a vial or a Combipack, **"C"** for **"Clear glass"** & **"A"** for **Amber glass vial**.
3. Do you want a writing patch? Digit 6, **"1"** for writing patch, **"0"** for vial without writing patch.

### STEP 4

When selecting a **Combipack** or just Closures, specification is determined as,

1. Digit 9 tells you the material type of the closure,
  - a. **"P"** for PLASTIC
  - b. **"A"** for aluminum
2. Digit 10, gives the color of the closure,
  - a. **"B"** for BLUE
  - b. **"C"** for CLEAR
  - c. **"S"** for Silver
  - d. **"K"** for Black
3. Digit 11, gives the type of closure,
  - a. **"S"** for Screw
  - b. **"C"** for Crimp
  - c. **"N"** for Snap
4. Digit 12, **"1"** for BONDED Septa **"0"** for NON BONDED Septa
5. Digits 13 & 14, help you determine the type of septa.

# Sample Vials & Closures

## 9mm Screw or Universally Compatible Vials

### VIAL : 2ml, 12 X 32mm Screw Top Vial. Clear or Amber Glass

9 mm screw thread vials are the most popular ones. They are also known as universally compatible vials. 9 mm screw top vials combine the excellent autosampler handling of a crimp cap profile with the ease of a screw cap. This means that they can be used in almost any autosampler.

### THE CLOSURE : BOROSIL certified pre-assembled PP screw caps & Septa.

Choose the best combination for your application.

PP Screw Cap with,

- PTFE / SILICONE Septa
- Pre-Slit PTFE/ SILICONE Septa
- BONDED PTFE/ SILICONE Septa
- BONDED Pre-slit PTFE/ SILICONE Septa



### To order only 9mm Screw Vials

Product Code	Description
VO02C00900S000	9mm, 2ml, 12 X 32, Clear Glass Screw Top Vial
VO02C10900S000	9mm, 2ml, 12 X 32, Clear Glass Screw Top Vial With <b>Write On</b> Patch
VO02A00900S000	9mm, 2ml, 12 X 32, <b>Amber</b> Glass Screw Top Vial
VO02A10900S000	9mm, 2ml, 12 X 32, <b>Amber</b> Glass Screw Top Vial, With <b>Write On</b> Patch



### To order only 9mm Screw Caps with Septa

Product Code	Description
CS000009PBS011	9mm, PTFE - Silicone Septa in a Blue Screw Cap
CS000009PBS012	9mm, <b>Pre-slit</b> PTFE-Silicone Septa in a Blue Screw Cap
CS000009PBS111	9mm, PTFE-Silicone Septa <b>BONDED</b> to a Blue Screw Cap
CS000009PBS112	9mm, <b>Pre-Slit</b> TYPE-A PTFE-Silicone Septa <b>BONDED</b> to a Blue Screw Cap
CS000009PBS113	9mm, Pre-Slit TYPE-B PTFE-Silicone Septa <b>BONDED</b> to a Blue Screw Cap
CS000009PBS115	9mm, Pre-Slit <b>BONDED Pre-slit</b> Red PTFE- White Silicone Septa
CS000009PKS001	9mm, Screw Closed Top Screw Caps with PTFE Lining

# Sample Vials & Closures

9mm Screw or Universally Compatible Vials

To order CombiPack **Of 9mm Clear Screw Vials With Matching Caps**

Product Code	Description
VC02C009PBS011	CombiPack of 9mm Clear Screw Vials & PTFE-Silicone Septa
VC02C109PBS011	CombiPack of 9mm Clear Screw Vial With <b>Write On</b> Patch & PTFE-Silicone Septa in a Blue Screw Cap
VC02C009PBS012	CombiPack of 9mm Clear Screw Vials & <b>Pre-Slit</b> PTFE-Silicone Septa
VC02C109PBS012	CombiPack of 9mm Clear Screw Vials With <b>Write On</b> Patch & <b>Pre-Slit</b> PTFE-Silicone Septa
VC02C009PBS111	CombiPack of 9mm Clear Screw Vials & PTFE- Silicone Septa <b>BONDED</b> to a Blue Screw Cap
VC02C109PBS111	CombiPack of 9mm Clear Screw Vials With <b>Write On</b> Patch & PTFE-Silicone Septa <b>BONDED</b> to a Blue Screw Cap
VC02C009PBS112	CombiPack of 9mm Clear Screw Vials & <b>Type-A Pre-Slit</b> PTFE-Silicone Septa <b>BONDED</b> to a Blue Screw Cap
VC02C109PBS112	COMBIPack of 9mm Clear Screw Vials With <b>Write On</b> Patch & <b>Type-A Pre-Slit</b> PTFE-Silicone Septa <b>BONDED</b> to a Blue Screw Cap
VC02C009PBS113	CombiPack of 9mm Clear Screw Vials & <b>Type-B Pre-Slit</b> PTFE-Silicone Septa <b>BONDED</b> to a Blue Screw Cap
VC02C109PBS113	CombiPack of 9mm Clear Screw Vials With <b>Write On</b> Patch & <b>Type-B Pre-Slit</b> PTFE-Silicone Septa <b>BONDED</b> to a Blue Screw Cap
VC02C009PBS115	Combi pack of 9mm 12X32 Clear Screw Vials and 9mm Screw Caps with <b>BONDED Pre-Slit</b> PTFE-Silicone Septa
VC02C109PBS115	Combi pack of 9mm 12X32 Clear Screw Vials with Write on Patch and 9mm Screw Caps with <b>BONDED Pre-Slit</b> PTFE-Silicone Septa
VC02C009PKS001	Combi pack of 9mm 12X32 Clear Screw Vials and 9mm Screw Closed Top Screw Caps with PTFE Lining
VC02C109PKS001	Combi pack of 9mm 12X32 Clear Screw Vials with <b>Write On</b> Patch and 9mm Screw Closed Top Screw Caps with PTFE Lining



Screw Cap

9 mm

2 ml

Vials



# Sample Vials & Closures

9mm Screw or Universally Compatible Vials

To order **Combipacks** of **9mm Amber Screw Vials With Matching Caps**

Product Code	Description
VC02A009PBS011	Combipack of 9mm <b>Amber</b> Screw Vials & PTFE-Silicone Septa
VC02A109PBS011	Combipack of 9mm <b>Amber</b> Screw Vial With <b>Write On</b> Patch & PTFE-Silicone Septa in a Blue Screw Cap
VC02A009PBS012	Combipack of 9mm <b>Amber</b> Screw Vials & <b>Pre-Slit</b> PTFE-Silicone Septa
VC02A109PBS012	Combipack of 9mm <b>Amber</b> Screw Vials With <b>Write On</b> Patch & <b>Pre-Slit</b> PTFE-Silicone Septa
VC02A009PBS111	Combipack of 9mm <b>Amber</b> Screw Vials & PTFE-Silicone Septa <b>BONDED</b> to a Blue Screw Cap
VC02A109PBS111	Combipack of 9mm <b>Amber</b> Screw Vials With <b>Write On</b> Patch & PTFE-Silicone Septa <b>BONDED</b> to a Blue Screw Cap
VC02A009PBS112	Combipack of 9mm <b>Amber</b> Screw Vials & <b>Type-A Pre-Slit</b> PTFE-Silicone Septa <b>BONDED</b> to a Blue Screw Cap
VC02A109PBS112	Combipack of 9mm <b>Amber</b> Screw Vials With <b>Write On</b> Patch & <b>Type-A Pre-Slit</b> PTFE-Silicone Septa <b>BONDED</b> to a Blue Screw Cap
VC02A009PBS113	Combipack of 9mm <b>Amber</b> Screw Vials & <b>Type-B Pre-Slit</b> PTFE-Silicone Septa <b>BONDED</b> to a Blue Screw Cap
VC02A109PBS113	COMBIPack of 9mm <b>Amber</b> Screw Vials With <b>Write On</b> Patch & <b>Type-B Pre-Slit</b> PTFE-Silicone Septa <b>BONDED</b> to a Blue Screw Cap
VC02A009PKS115	Combipack of 9mm 12 x 32 <b>Amber</b> Screw Vials and 9mm Screw Caps with <b>BONDED Pre-Slit</b> PTFE-Silicone Septa
VC02A109PKS115	Combipack of 9mm 12 x 32 <b>Amber</b> Screw Vials with <b>Write On</b> Patch and 9mm Screw Caps with <b>BONDED Pre-Slit</b> PTFE-Silicone Septa
VC02A009PKS001	Combipack of 9mm 12 x 32 <b>Amber</b> Screw Vials and 9mm Screw Closed Top Screw Caps with PTFE Lining
VC02A109PKS001	Combipack of 9mm 12 x 32 <b>Amber</b> Screw Vials with <b>Write On</b> Patch and 9mm Screw Closed Top Screw Caps with PTFE Lining

Screw Cap



9 mm

2 ml

Vials



## 11mm Snap Vials

### VIAL: 2ml, 12 X 32mm Snap Top Vial. Clear or Amber Glass

Snap top Vials and caps are the simple, efficient way to ensure a secure seal without crimping. Snap caps provide a secure seal that minimises evaporation even with volatile samples. Snap caps are often more convenient than crimp caps as they can easily be applied and removed by hand. An audible 'click' reinforces that a secure seal has been ensured, and that the cap is correctly aligned.

### THE CLOSURE:

For quick and easy use, Borosil caps and septa are pre-assembled. This saves your time and reduces the risk of contamination during assembly. As easy as 'push-on, pull-off', the secure seal Borosil snap caps have are clearly advantages over the loose fit of other snap caps. Crimp caps can also be used with Borosil's wide opening snap top Vials.

### To order only 11mm Snap Vials

Product Code	Description - 100 /pk
VO02C01100N000	11mm, 2ml Clear Glass Snap Vial
VO02C11100N000	11mm, 2ml Clear Glass Snap Vial With <b>Write On</b> Patch
VO02A01100N000	11mm, 2ml Amber Glass Snap Vial
VO02A11100N000	11mm, 2ml Amber Glass Snap Vial, With <b>Write On</b> Patch



### To order only 11mm Snap Caps with Septa

Product Code	Description 100 / pk
CS000011PCN011	11mm, PTFE-Silicone Septa in a Clear Snap Cap
CS000011PCN012	11mm, Pre-slit PTFE-Silicone Septa in a Clear Snap Cap



Snap

11 mm

2 ml

Vials

## 11mm Snap Vials

To order **11mm Combipacks Of Clear Snap Vials With Matching Caps**



Product Code	Description
VC02C011PCN011	Combipack of 11mm Clear Snap Vial & PTFE-Silicone Septa in a Clear Snap Cap
VC02C011PCN012	Combipack of 11mm Clear Snap Vial & <b>Pre-Slit</b> PTFE-Silicone Septa in a Clear Snap Cap
VC02C111PCN011	Combipack of 11mm Clear Snap Vial With <b>Write On</b> patch & PTFE-Silicone Septa in a Clear Snap Cap
VC02C111PCN012	Combipack of 11mm Clear Snap Vial With <b>Write On</b> Patch & <b>Pre-Slit</b> PTFE-Silicone Septa in a Clear Snap Cap

To order **Combipacks Of 11mm Snap Amber Vials With Matching Caps**



Product Code	Description / 100 pk
VC02A011PCN011	Combipack of 11mm <b>Amber</b> Snap Vial & PTFE-Silicone Septa in a Clear Snap Cap
VC02A011PCN012	Combipack of 11mm <b>Amber</b> Screw Vial & <b>Pre-Slit</b> PTFE-Silicone Septa in a Clear Snap Cap
VC02A111PCN011	Combipack of 11mm <b>Amber</b> Snap Vial With <b>Write On</b> Patch & PTFE-Silicone Septa in a Clear Snap Cap
VC02A111PCN012	Combipack of 11mm <b>Amber</b> screw vial with <b>Write On</b> Patch & <b>Pre-slit</b> PTFE-Silicone septa in a Clear Snap Cap

Snap

11 mm

2 ml

Vials

## 11mm Crimp Vials

### VIAL : 2ml, 12 X 32mm Crimp Top Vial. Clear or Amber Glass

Borosil Crimp Vials are made to exacting dimensions for unparalleled autosampler compatibility, including a precision-formed crown for better crimping.

#### THE CLOSURE:

Crimp caps ensure the tightest seal, reducing the possibility of sample evaporation. The 12 x 32 mm Crimp Vials and 11 mm aluminium crimp caps are economical and easy to use. The wide opening crimp cap provides a larger target area for enhanced autosampler needle accuracy.

Choose from Septa best suited to your application.

PTFE-Silicone or Pre-slit PTFE Silicone.

#### To order only 11mm Crimp Vials

Product Code	Description - 100 /pk
VO02C01100C000	11mm, 2ml Clear Glass Crimp Vial
VO02C11100C000	11mm, 2ml Clear Glass Crimp Vial With <b>Write On</b> Patch
VO02A01100C000	11mm, 2ml Amber Glass Crimp Vial
VO02A11100C000	11mm, 2ml Amber Glass Crimp Vial, With <b>Write On</b> Patch



#### To order only 11mm Crimp Caps with Septa

Product Code	Description 100 / pk
CS000011ASC011	11mm, PTFE - Silicone Septa in a Aluminum Crimp Cap
CS000011ASC012	11mm, <b>Pre-Slit</b> PTFE-Silicone Septa in a Aluminum Crimp Cap
CS000011ASC021	11mm Aluminum Crimp Caps with PTFE-Orange Silicone Septa
CS000011ASC022	11mm Aluminum Crimp Caps with <b>Pre-Slit</b> PTFE-Orange Silicone Septa

Crimp

11 mm

2 ml

Vials

To order **11mm Combipacks Of Clear Crimp Vials With Matching Caps**

Product Code	Description / 100 pk
VC02C011ASC011	Combipack of 11mm Clear Crimp Vial & PTFE-Silicone Septa in a Aluminum Crimp Cap
VC02C011ASC012	Combipack of 11mm Clear Crimp Vial & <b>Pre-Slit</b> PTFE-Silicone Septa in a Aluminum Crimp Cap
VC02C011ASC021	Combipack of 11mm Clear Glass Crimp Vials 12 x 32 and 11mm Aluminum Crimp Caps with PTFE-Orange Silicone Septa
VC02C011ASC022	Combipack of 11mm Clear Glass Crimp Vials 12 x 32 and 11mm Aluminum Crimp Caps with <b>Pre-Slit</b> PTFE-Orange Silicone Septa
VC02C111ASC011	Combipack of 11mm Clear Crimp Vial With <b>Write On</b> patch & PTFE-Silicone Septa in a Aluminum Crimp Cap
VC02C111ASC012	Combipack of 11mm Clear Crimp Vial With <b>Write On</b> patch & <b>Pre-Slit</b> PTFE-Silicone Septa in a Aluminum Crimp Cap
VC02C111ASC021	Combipack of 11mm Clear Glass Crimp Vials 12 x 32 with <b>Write On</b> Patch and 11mm Aluminum Crimp Caps with PTFE-Orange Silicone Septa
VC02C111ASC022	Combipack of 11mm Clear Glass Crimp Vials 12 X 32 with <b>Write On</b> Patch and 11mm Aluminum Crimp Caps with PTFE-Orange Silicone Septa

Crimp



11 mm

2 ml

Vials

To order **Combipacks Of Amber Crimp Vials With Matching Caps**

Product Code	Description / 100 pk
VC02A011ASC011	Combipack of 11mm <b>Amber</b> Crimp Vial & PTFE-Silicone Septa in a Aluminum Crimp Cap
VC02A011ASC012	Combipack of 11mm <b>Amber</b> Crimp Vial & <b>Pre-Slit</b> PTFE-Silicone Septa in a Aluminum Crimp Cap
VC02A011ASC021	Combipack of 11mm <b>Amber</b> Glass Crimp Vials 12 x 32 and 11mm Aluminum Crimp Caps with PTFE-Orange Silicone Septa
VC02A011ASC022	Combipack of 11mm <b>Amber</b> Glass Crimp Vials 12 x 32 and 11mm Aluminum Crimp Caps with PTFE-Orange Silicone Septa SEPTA
VC02A111ASC011	Combipack of 11mm <b>Amber</b> Crimp Vial With <b>Write On</b> Patch & PTFE-Silicone Septa in a Aluminum Crimp Cap
VC02A111ASC012	Combipack of 11mm <b>Amber</b> Crimp Vial With <b>Write On</b> patch & <b>Pre-Slit</b> PTFE-Silicone Septa in a Aluminum Crimp Cap
VC02A111ASC021	Combipack of 11mm <b>Amber</b> Glass Crimp Vials 12 x32 with <b>Write On</b> Patch and 11mm Aluminum Crimp Caps with PRE-Slit PTFE-Orange Silicone Septa
VC02A111ASC022	Combipack of 11mm <b>Amber</b> Glass Crimp Vials 12 x 32 with <b>Write On</b> Patch and 11mm Aluminum Crimp Caps with PRE-Slit PTFE-Orange Silicone Septa



## 13mm Screw or Rinse Vials

### VIAL: 4ml 15 X 45mm Screw Vial, Clear or Amber Glass

These 15 x 45 mm Vials can hold up to 4ml of sample. They are used by the Waters 48-position autosampler, Agilent's (G2880A) autosampler tray used with the Agilent 6850, in 7673 and 7683 autosamplers. These Vials can also be used in the Perkin-Elmer Autosystem GC, Shimadzu AOC-14/1400, LC-10A, and SIL-2AS. They can be used as sample or wash Vials, or even as waste Vials.

With 13 x 425 caps and septa they are used as sample Vials. These Vials can also be used as storage Vials.

#### To order only 13mm Screw Vials

Product Code	Description - 100 /pk
VO04C11300S000	13mm, 4ml Clear Glass Screw Vial With <b>Write On Patch</b>
VO04A11300S000	13mm, 4ml Amber Glass Screw Vial With <b>Write On Patch</b>



Screw Cap

#### To order only 13mm Screw Caps with Septa

Product Code	Description 100 / pk
CS000013PKS011	13mm PTFE - Silicone Septa in a Blue Screw Cap



13 mm

#### To order Combipacks Of 13mm Screw Vials With Matching Caps

Product Code	Description 100 / pk
VC04C113PKS011	Combipack of 13 mm Clear Screw Vial & PTFE-Silicone Septa in a Black Screw Cap



|

4 ml

#### To order Combipacks Of 13mm Screw Amber Vials With Matching Caps

Product Code	Description 100 / pk	Price
VC04A113PKS011	Combipack of 13 mm Clear Screw Vial & PTFE-Silicone Septa in a Black Screw Cap	



Vials

## EPA Vials



To order **EPA Pre-Assembled Vials**

Product Code	Description
VC20C124PWS111	20ml Clear Glass EPA Vial with PTFE Silicone Septa Bonded to a 24mm White Screw Cap
VC30C124PWS111	30ml Clear Glass EPA Vial with PTFE Silicone Septa Bonded to a 24mm White Screw Cap
VC40C124PWS111	40ml Clear Glass EPA Vial with PTFE Silicone Septa Bonded to a 24mm White Screw Cap
VC60C124PWS111	60ml Clear Glass EPA Vial with PTFE Silicone Septa Bonded to a 24mm White Screw Cap
VC20A124PWS111	20ml <b>Amber</b> Glass EPA Vial with PTFE Silicone Septa Bonded to a 24mm White Screw Cap
VC30A124PWS111	30ml <b>Amber</b> Glass EPA Vial with PTFE Silicone Septa Bonded to a 24mm White Screw Cap
VC40A124PWS111	40ml <b>Amber</b> Glass EPA Vial with PTFE Silicone Septa Bonded to a 24mm White Screw Cap
VC60A124PWS111	60ml <b>Amber</b> Glass EPA Vial with PTFE Silicone Septa Bonded to a 24mm White Screw Cap

Screw Cap

13 mm

2 ml

Vials

## 20mm Headspace GC Vials

To order only **20ml GC Vials**

Product Code	Description - 100 /pk	Price / Case lot of 5 x 100 pcs ₹
VO20F12000C000	Clear Glass, Flat Bottom, Headspace Crimp Vial 20mm	14180.00
VO20R12000C000	Clear Glass, Round Bottom, Headspace Crimp Vial 20mm	14180.00
VO20F12000S000	Clear Glass Flat Bottom Headspace Screw Vial 20ml	19180.00
VO20R12000S000	Clear Glass Round Bottom Headspace Screw Vial 20ml	21165.00



GC Headspace

To order only **20mm GC Vials Caps with Septa**

Product Code	Description - 100 /pk
CS000020ASC051	Headspace Aluminum Crimp Caps with PTFE-Silicone Septa
CS000020ASC041	20mm GC Headspace Aluminum Crimp Cap with Ultra Clean, Ultra Low Bleed PTFE-Silicone Septa
CS000020MSC041	20mm GC Headspace Magnetic Crimp Cap with Ultra Clean, Ultra Low Bleed PTFE-Silicone Septa

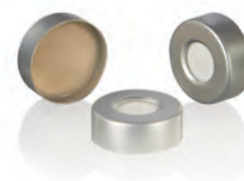

20 mm

To order only **Headspace Magnetic Screw Cap Closure**

Product Code	Description - 100 /pk
CS000020MSS061	Headspace Magnetic Screw Caps with PTFE-Silicone Septa

20 ml

Vials

GC Headspace

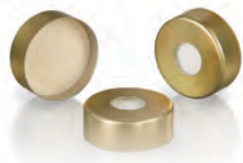

To order **Combi packs Of 20mm GC Flat Bottom Vials With Matching Caps**

Product Code	Description - 100 /pk
VC20F120ASC051	Combi pack of 20ml Clear Glass Flat Bottom Headspace Crimp Vial and Headspace Aluminum Crimp Caps with PTFE-Silicone Septa
VC20F120ASC041	Clear Glass, Flat Bottom, printed Headspace Vials with 20mm Aluminum Crimp Cap with Ultra Clean, Ultra Low-Bleed, PPTFE-Silicone Septa
VC20F120MSC041	Clear glass, Flat Bottom, Printed Headspace Vials With 20mm Magnetic Crimp Cap With Ultra Clean, Ultra low-bleed, PTFE-Silicone Septa

20 mm



To order **Combi packs Of 20mm GC Flat Bottom Vials With Matching Caps**

Product Code	Description - 100 /pk
VC20R120ASC051	Combi pack of 20ml Clear Glass Round Bottom Headspace Crimp Vial and Headspace Aluminum Crimp Caps with PTFE-Silicone Septa
VC20R120ASC041	Clear Glass, Round Bottom, Printed Headspace Vials With 20mm Aluminum Crimp Cap with Ultra Clean, Ultra Low-Bleed, PTFE-Silicone Septa
VC20R120MSC041	Clear Glass, Round Bottom, Printed Headspace Vials With 20mm Magnetic Crimp Cap With Ultra Clean, Ultra low-bleed, PTFE-Silicone Septa

20 ml

To order **Combi packs Of 20mm GC Flat Bottom Vials With Matching Caps**

Product Code	Description - 100 /pk
VC20F120MSS061	Combi pack of 20ml Clear Glass Flat Bottom Headspace Screw Vial and Headspace Magnetic Screw Caps with PTFE-Silicone Septa

Vials

To order **Combi packs of 20ml Round Bottom Screw Vials With Matching Caps**

Product Code	Description - 100 /pk
VC20R120MSS061	Combi pack of 20ml Clear Glass Round Bottom Headspace Screw Vial and Headspace Magnetic Screw Caps with PTFE-Silicone Septa



## Headspace Vials & Closures

To order only **10 ml Headspace Vials**

Product Code	Description - 100 /pk
VO10F12000C000	10ml Clear Glass Flat Bottom Headspace Crimp Vial
VO10R12000C000	10ml Clear Glass Round Bottom Headspace Crimp Vial
VO10F12000S000	10ml Clear Glass Flat Bottom Headspace Screw Vial
VO10R12000S000	10ml Clear Glass Round Bottom Headspace Screw Vial

To order **10ml Flat Bottom Crimp Vials with Closures**

Product Code	Description - 100 /pk
VC10F120ASC051	Combipack of 10ml Clear Glass Flat Bottom Headspace Crimp Vial and Headspace Aluminum Crimp Caps with PTFE-Silicone Septa
VC10F120ASC041	Combi pack of 10ml Clear Glass Flat Bottom Headspace Crimp Vial and Headspace Aluminum Crimp Caps with Ultra Low Bleed PTFE-Silicone Septa
VC10F120MSC041	Combi pack of 10ml Clear Glass Flat Bottom Headspace Crimp Vial and Headspace Magnetic Crimp Caps with Ultra Low Bleed PTFE-Silicone Septa



To order **10ml Round Bottom Crimp Vials with Closures**

Product Code	Description - 100 /pk
VC10R120ASC051	Combipack of 10ml Clear Glass Round Bottom Headspace Crimp Vial and Headspace Aluminum Crimp Caps with PTFE-Silicone Septa
VC10R120ASC041	Combi pack of 10ml Clear Glass Round Bottom Headspace Crimp Vial and Headspace Aluminum Crimp Caps with Ultra Low Bleed PTFE-Silicone Septa
VC10R120MSC041	Combi pack of 10ml Clear Glass Round Bottom Headspace Crimp Vial and Headspace Magnetic Crimp Caps with Ultra Low Bleed PTFE-Silicone Septa

To order **10ml HS Screw Vials with Closures**

Product Code	Description - 100 /pk
VC10F120MSS061	Combi pack of 10ml Clear Glass Flat Bottom Headspace Screw Vial and Headspace Magnetic Screw Caps with PTFE-Silicone Septa
VC10R120MSS061	Combi pack of 10ml Clear Glass Round Bottom Headspace Screw Vial and Headspace Magnetic Screw Caps with PTFE-Silicone Septa

# Sampling, Storage & Special Purpose Vials

Vials made of Type I Borosilicate glass, with different volumes in clear and amber.

These are non-stock items and may require a minimum order quantity.



Capacity ml	3ml	6ml	8ml	10ml
Dimension H X D mm	41 x 11.6 mm	41 x 22 mm	61 x 16.6mm	50 x 22mm
Mouth Type	Crimp Neck	Crimp Neck	Screw Neck	Flip Neck
Mouth Diameter mm	11 mm	20 mm	15mm	18mm
Clear	VO03C01100C000	VO06CF2000C000	VO08C01500S000	VO10C01800N000
Amber	VO03A01100C000	VO06AF2000C00	VO08A01500S000	—
Pack Size	1000/pk	1000/pk	1000/pk	1000/pk
Suggested Cap	CS000011ASC011	CS000020ASC051	CS000015PKS011	CS000018PCN000
Application	Storage	Storage	Storage	Storage/ Sampling



15ml	25ml	30ml	16ml	20ml
48 X 26mm	65 X 26mm	66 X 30mm	71 x 20.6mm	86 x 22.7
Flip Neck	Flip Neck	Flip Neck	Screw Neck	Screw Neck
22mm	22mm	30mm	18mm	20mm
VO15C02200N000	VO25C02200N000	VC30C130PCN000	VO16C01800S000	VO20C02000C000
—	—	VC30A130PCN000	VO16A01800S000	VO20A02000C000
1000/pk	1000/pk	1000/pk	1000/pk	1000/pk
CS000022PCN000	CS000022PCN000	Supplied with cpas	CS000018PKS011	CS000020PWS011
Storage/ Sampling	Storage/ Sampling	Process sampling (IPQA)	Storage	Storage

### Technical Information on Closures for Special purpose/ Storage vials

Product Code	Description	Pack Size	Compatible with
CS000015PKS011	15mm Closed top Screw Cap with PTFE-SILICONE septa 100/pk	100/pk X 10	VO08C01500S000
			VO08A01500S000
CS000018PCN000	18mm Clear Flip Top Cap 1000/pk	1000/pk x 10	VO10C01800N000
CS000022PCN000	22mm Clear Flip Top Cap 1000/pk	1000/pk x 10	VO15C02200N000
			VO25C02200N000
CS000018PKS011	18mm Black Closed top Screw Cap with PTFE-SILICONE Septa 100/pk	100/pk X 10	VO16C01800S000
			VO16A01800S000
CS000020PWS011	20mm White Closed Top Screw Cap with PTFE -SILICONE Septa 100/pk	100/pk x 10	VO20C02000C000
			VO20A02000C000

# Microscope Slides & Cover Glasses

## Conforms to ISO 8037 standard

- Fine ground edges slide are manufactured by state-of-art manufacturing process which results in a high quality and polished ground edges.
- Refractive index of  $1.53 \pm 0.02$
- From extremely uniform, thin and flat glass sheets which are very resistant to corrosion and fogging.
- The slide is used for routine microscopy application.



## 9100 - Microscope Slides

- Made from the finest white glass
- Uniform quality
- High- Precision ground edges on all four sides
- Thin, Flat and resistant to corrosion or fogging
- Pre-cleaned and ready to use
- Subjected to strict quality control checks, examined individually and environmentally controlled dry before packaging
- Specially designed for meeting the stringent needs of users
- Free from all visual defects

9100P02 - Plain



9100D01 - Double Frosted



Product Code	Description	Pack Size mm L x B x WT	Quantity Per Packet No.	Packets / Case
9100P02	Plain, Ground Edges	76 x 26 x 1	50	25
9100D01	Double Frosted, Ground Edges	76 X 26 X 1	50	25

L : Length x B : Breadth x WT : Wall Thickness



Individual Shrink Wrap to avoid fogging

## 9115 - Cover glass

- Made from the finest white glass with excellent quality
- Uniform quality
- Available in both square and rectangular shape
- Cover glass is cut, cleaned, sorted and weighed
- Resistance to corrosion and fogging
- Free from ragged edges, oily film and finger prints
- Packed in reclosable plastic boxes for protection during storage
- Pre cleaned and ready to use
- Subjected to strict quality control checks, examined individually and environmentally controlled to dry before packaging

9115S01 - Square



9115S02 - Square



9115S03 - Square

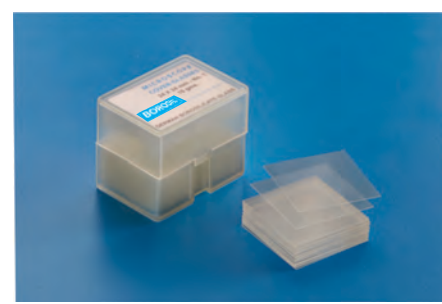

Product Code	Description	Pack Size mm	Quantity Per Packet / Piece	Packets / Case
9115S01	Square	18 x 18	100	50
9115S02	Square	22 x 22	100	50
9115S03	Square	24 x 24	100	50

9115R01 - Rectangular



9115R02 - Rectangular



9115R03 - Rectangular

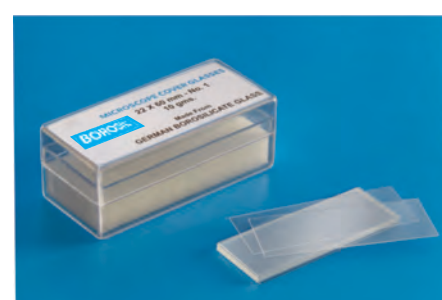

Product Code	Description	Pack Size mm	Quantity Per Packet / Piece	Packets / Case
9115R01	Rectangular	22 x 40	100	50
9115R02	Rectangular	22 x 50	100	50
9115R03	Rectangular	22 x 60	100	50

"VETROCLEAN is a Phosphate FREE alkaline detergent made up of high quality anionic & non-ionic surfactants with total solid content between 17% - 20%"



- This is special cleaner for glass, quartz and sensitive metals.
- Bio-degradable.
- pH 6-8, for 2% – 5% solution.
- Foam Tendency – Non foaming at 2%-5% concentrations.
- Best suited for Manual Cleaning, Soak & CIP, Machine Washers.
- No residue after proper cleaning.
- Non hazardous.
- Free from scents/toxic ingredients.



### 9001 - Vetroclean

Product Code	Capacity ml	Quantity Per Case
9001024	500	6
9001033	5000	1
9001041	25000	1

MSDS available on request

# BOROSIL® Lab Accessories

## TONGS FOR BEAKERS & FLASKS



- Made of stainless steel
- Used to handle hot beakers & flasks
- Provided with silicon sleeves or in fibre glass yarn to resist direct flame

Product Code	Description	Size Inches	Case Lot No.
LATG8888P10	Beaker tong	10	6
LATG8888B10	Beaker tong	12	6
LATG8888F10	Flask tong	10	6



## TONGS FOR CRUCIBLE

- Made of Stainless Steel
- Used to handle hot crucibles

Product	Description	Size	Case Lot
LACT8888006	Crucible tong with bow stainless steel	6	6
LACT8888008	Crucible tong with bow stainless steel	8	6
LACT8888012	Crucible tong with bow stainless steel	12	6



## CLAMPS

- Available in Zinc & Aluminium diecasted
- It is coated with LEAD-FREE powder coating & fitted with brass screw which makes it totally RUST-FREE CLAMP
- Two & three finger clamp Jaws can be covered with PVC sleeves
- Two & four finger clamp has cork lined Jaws holds upto 90 mm articles
- It is provided with 8 mm diameter & 150 mm long Stainless Steel(Grade 201)rod

Product	Description	Case Lot No.
L AFC8888Z02	Two finger clamp, Zinc pressure die casted	10
L AFC8888AD3	Three finger clamp, Aluminum pressure die casted	10
L AFC8888ZD4	Four finger clamp, Zinc pressure die casted	10
L AFC8888AD4	Four finger clamp Aluminum pressure die casted	10



## CLAMPS WITH BOSSHEAD

- Available in Zinc & Aluminium diecasted
- It is coated with LEAD-FREE powder coating & fitted with brass screw which makes it totally RUST-FREE CLAMP
- Two & three finger clamp Jaws can be covered with PVC sleeves
- Two & four finger clamp has cork lined Jaws holds upto 90 mm articles
- With adjustable bosshead attached clamp length can be vary, can be rotated 360° and locked at any angle

Product Code	Description	Case Lot No.
L AFC8888Z03	Two finger clamp (Zinc PDC) with adjustable bosshead	12
L AFC8888A03	Three finger clamp (Aluminium PDC) with adjustable bosshead	12
L AFC8888Z04	Four finger clamp (Zinc PDC) with adjustable bosshead	12
L AFC8888A04	Four finger clamp (Aluminium PDC) with adjustable bosshead	12



## UNIVERSAL CLAMPS

- Single Burette / Test Tube Clamp made of stainless steel Jaws & Aluminium bosshead
- Round jaws are covered with PVC coating
- Opens from 15 mm to 45 mm in Diameter
- Clamps attaches to rods up to 13 mm in diameter. Threaded rod and wing nut adjust clamp angle and overall length from 13 cm to 15 cm

Product Code	Description	Case Lot No.
L ABC8888SC1	Single Burette clamp, PVC coated jaws stainless steel	12
L ABC8888S01	Single Burette clamp, PVC uncoated jaws, stainless steel	12



## BURETTE CLAMPS

- Single / Double Burette clamp is made of Aluminium die casting
- Feature black PVC sleeves for firm gripping of burettes.
- This adjustable burette clamp is suitable for all burettes up to 100 ml which are held in place by the pressure created by the springs yet allows easy operation without damaging glassware.

Product Code	Description	Case Lot No.
L ABC8888B01	Single burette clamp, Aluminium PDC <b>Fig. A</b>	6
L ABC8888A02	Double burette clamp, Aluminium PDC <b>Fig. B</b>	6
L ABC8888AE1	Single burette clamp, Aluminium PDC (Eco.) <b>Fig. C</b>	6
L ABC8888AE2	Double burette clamp, Aluminium PDC (Eco.) <b>Fig. D</b>	6

A



B



C



D



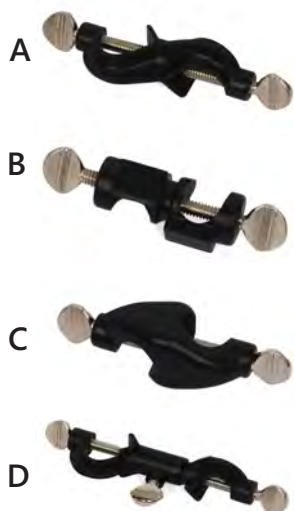

## BOSSHEDS

- Bosshead made of Zinc & Aluminum pressure die casted
- It can hold a rod upto 16 mm diameter at 90° angle and Swivel bosshead rotate at 360° angle
- It is coated with LEAD-FREE powder coating & fitted with Nickel plated thumb screw

Product Code	Description	Case Lot
LABH8888RBL	Regular bosshead Zinc PDC <b>Fig. A</b>	12
LABH8888OBL	Round bosshead Zinc PDC <b>Fig. B</b>	12
LABH8888JBL	Jumbo bosshead Aluminum PDC <b>Fig C</b>	12
LABH8888SBL	Swivel bosshead Zinc PDC <b>Fig. D</b>	12

## RETORT RING

- Strong circular mild steel ring with 6 mm diameter stem
- Open bosshead fitted with thumb screw to accept rods from 8 mm to 15 mm diameter



Product Code	Description	Size in inches	Case Lot No.
LARR8888003	Retort Ring with bosshead	3	6
LARR8888004	Retort Ring with bosshead	4	6

## RETORT BASE

- Superior Heavy duty steel alloy stand with rubber lining on a shorter side gives extra stability
- With lead-free powder coating



Product Code	Description	Size inches	Case Lot No.
LARB8888H06	Retort base, Heavy	6" x 4"	6
LARB8888H08	Retort base, Heavy	8" x 5"	6
LARB8888H10	Retort base, Heavy	10" x 6"	6

## ROD FOR RETORT BASE

- With stainless steel Grade 201

Product Code	Description	Approx O.D. x Height mm	Case Lot No.
LARS8888500	Retort Rod (SS Grade 201)	12 x 500	2
LARS8888600	Retort Rod (SS Grade 201)	12 x 600	2
LARS8888750	Retort Rod (SS Grade 201)	12 x 750	2



## TEST TUBE STAND

- It is made of Aluminum sheet, Z type, new design, single piece fabrication
- One row of holes of 30 mm diameter, the second row of holes of 25 mm diameter and third row of hole of 16 mm diameter
- This aluminium Z shape design is Coated with lead free powder coating make it corrosion resistant

Product Code	Description	Case Lot No.
LATS8888H19	Z' Shape Test Tube Stand, Aluminum, 19 hole assorted	6
LATS8888H25	'Z' Shape Test tube stand, 25 hole for 16mm tube	6



## TEST TUBE HOLDER

- A pair of spring strip of hard rolled stainless steel, mounted in wooden handle in cross-scissor shape, and accepts tubes of diameter 12-43 mm.
- Overall length about 225mm

Product Code	Description	Case Lot No.	Price / Piece ₹
LATH8888000	Test tube holder, cross pattern, Stainless steel	24	170.00



## BURNERS

- Bunsen Burner 13mm/11mm ideal for use with natural gas and L.P.G.
- Nickel-plated brass burner tube with Rotatable air regulator
- Enamelled Zinc pressure die casted base
- Base diameter 80 mm

Product Code	Description	Caselot No.
LABR8888Z11	Bunsen burner, Zinc PDC base with 11mm brass pipe for L.P. G. <b>Fig. A</b>	2
LABR8888Z13	Bunsen burner, Zinc PDC base with 13mm brass pipe for L.P. G. <b>Fig. B</b>	2
LABR8888013	Burner, sheet metal base with 13mm pipe, for L.P. G. <b>Fig. C</b>	2

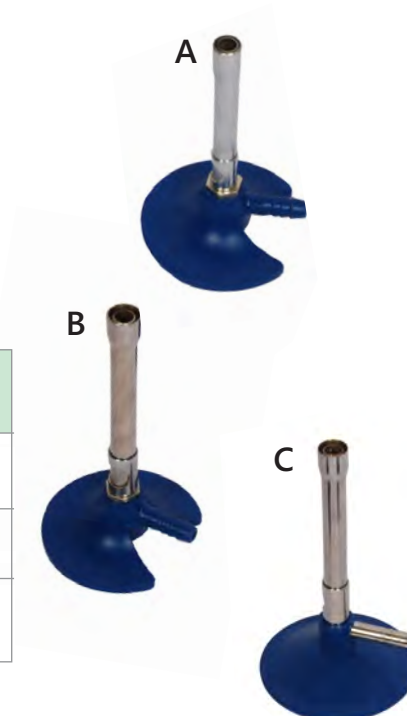

## SPATULAS

- Made of stainless steel grade 202
- Spatulas are used for measuring solids moving objects and scraping material out of
- beakers

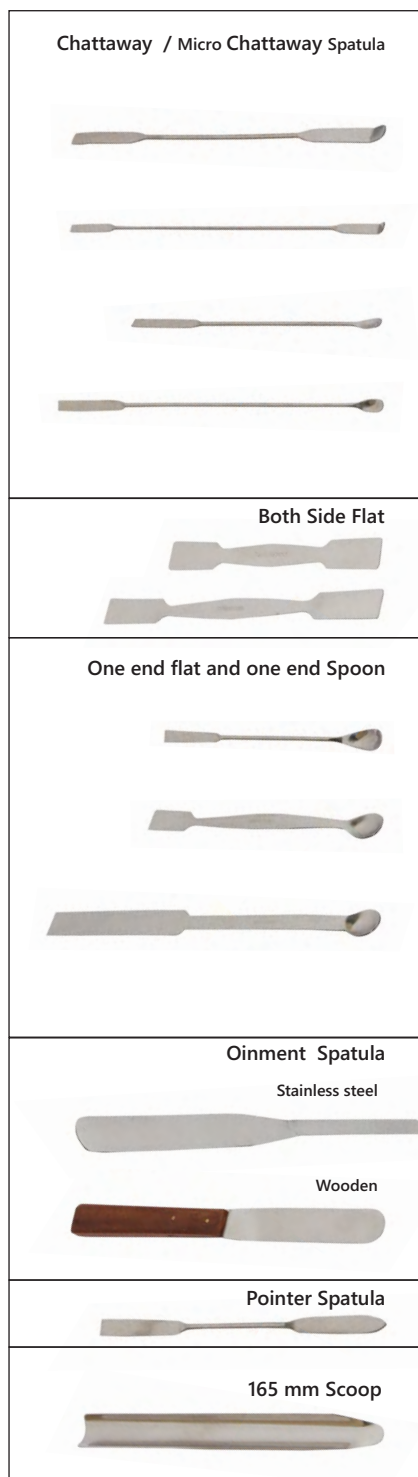

Product Code	Description	Size in inches	Case Lot No.
LACS8888006	Chattaway Spatula	6	20
LACS8888008	Chattaway Spatula	8	20
LASL8888C08	Micro Chattaway Spatula	8	20
LASC8888M06	Micro Scoop	6	10
LASC8888SM6	Semi Micro Spatula	6	10
LASL8888075	Big Spoon Spatula	7.5	10
LASL8888075	Big Spoon Spatula	7.5	10
LASP8888B06	Both side flat	6	20
LASP8888B08	Both side flat	8	20
LASP8888004	One end flat and one end Spoon	4	50
LASP8888006	One end flat and one end Spoon	6	50
LASP8888008	One end flat and one end Spoon	8	50
LASP8888010	One end flat and one end Spoon	10	50
LASP8888012	One end flat and one end Spoon	12	50
LASO8888W04	Ointment Spatula Wooden Handle	4	10
LASO8888W06	Ointment Spatula Wooden Handle	6	10
LATG8888S06	Ointment Spatula Forged Stainless Steel	6	10
LASL8888P06	Pointer Spatula	6	10
LASC8888165	165 mm Scoop	6.5	10
LASL8888510	Big Spoon Spatula	10	10

Did  
You  
Know?

**Speciality Laboratory  
Products**

“ Inline with our mission & vision BOROSIL is committed to introduce world class laboratory equipments in the speciality laboratory products (SLP) group.

SLP products are backed with a highly responsive service set-up to ensure hassle-free performance. ”

**BOROSIL<sup>®</sup>**  
service centre

For technical assistance / queries on Speciality Products  
call **1800-224-551** or email **support@borosil.com**

# Vortex Mixers

VMP / VMS / VMSP

LabQuest vortex mixers produce powerful vortex action with inbuilt counter balance for stable and silent operation.

The premium VMSP vortexer comes with digital display, programmable pulse mode and toggle parameter indication.



Accessories  
FREE





**VMP**

Code : **100VMP00045000**



**VMS**

Code : **100VMS00028000**



**VMSP**

Code : **100VMSP0042000**

### Technical Information

Specification	VMP	VMS	VMSP
Max (rpm)	4500	2800	4200
Orbital diameter (mm)	4.5	4.00	4.00
Motor	BLDC	AC	BLDC
Display	-	-	digital
Max load in gm	500	500	500
Speed control	-	Yes	Yes
Dimension (W X D X H) in mm	100 x 100 x 70	205 x 136 x 138.5	205 x 136 x 138.5
Product code	100VMP00045000	100VMS00028000	100VMSP0042000

# Multi Tube Vortexer

## VMMT

LabQuest multi tube vortexer produce powerful vortex action with inbuilt counter balance for stable and silent operation.

The multi tube vortexer comes with digital display, programmable pulse mode, compatible with 7 / 15 / 50 ml multi tubes and 250 ml conical flask.

Accessories  
**FREE**

attachment for Tubes for multi tubes 7 / 15 / 50 ml and 250 ml conical flask.







**VMMT**

Code : **100VMMT6025000**

## Technical Information

Specification	VMMT
rpm	300-2500
Timer	1-999 mins & infinite
Motion Type	Clockwise and Counter clockwise motion
Pulse Mode	Programmable Pulse
Display	Digital
Motor Type	BLDC
Protection Class	IP 21
Weight	18kg
Power Consumption	75W

# Motorless Magnetic Stirrers

MS ONE / MS FOUR

Truly maintenance free with no moving parts. Ultra thin design just 12mm thick. The SS top surface provides protection against damage due to spillage.





**MS ONE**

Code : **100MS000115000**



**MS FOUR**

Code : **100MS000412000**

### Technical Information

Specification	MS One	MS Four
Max (rpm)	1500	1200
Increment speed (from 15 rpm)	50	50
Display	digital	digital
Max load (ml)	800	4 x 500
Magnetic bar length (mm)	25	25
Pulse mode	Yes	Yes
Dimension (W X D X H) in mm	156 x 110 x 13.2	457 x 126 x 13.4
Protection class	IP64	IP64
Product code	100MS000115000	100MS000412000

# Multi position stirrers with / without heating

5 P / 10 P / 15 P

Multi position stirrers with slip-less speed regulation, homogenous temperature distribution and brushless motor for maintenance free operation.

The closed design allows for easy cleaning, safety and protection against spillage.





**MHPs 5 P**



**MHPs 10 P**



**MHPs 15 P**

### Technical Information

Specification	MHPs 5P	MHPs 10P	MHPs 15P
Stirring positions	5	10	15
Speed (rpm)	1500	1500	1500
Display	digital	digital	digital
Incremental speed (from 15 rpm)	10	10	10
Max capacity in lit	2	4	6
Temp range (from ambient)	120°C	120°C	120°C
Dimension (W X D X H) in mm	562 x 136 x 75	565 x 196 x 75	568 x 282 x 76
Set up plate in mm	456 x 118	460 x 178	460 x 264
Pulse mode	Yes	Yes	Yes
Product code (with heating)	100MHPs0515000	100MHPs1015000	100MHPs1515000
Product code (without heating)	100MS000515000	100MS001015000	100MS001515000

# High Capacity Magnetic Stirrers

**MS 50 L / MS 200 L**

Heavy duty stirring operation with acceleration control. Available with support frame which is height adjustable.

Safety feature includes protection against electrical power overload and stainless steel set-up plate for corrosion protection.

Auto power mode for resumption of operation in case of power failure.





**MS 50 L**

Code : **100MS05011000R**



**MS 200 L**

Code : **100MS20010600R**

## Technical Information

Specification	MS 50 L	MS 200 L
Capacity in Lit	50	200
rpm	100-1000	100-600
Timer	1-99.59 mins & infinite	1-99.59 mins & infinite
Pulse Mode	Yes	Yes
Display	Digital	Digital
Accuracy	+/- 10 rpm	+/- 10 rpm
Protection Class	IP 21	IP 21
Max Stir Bar length in mm	80	120
Plate Dimension	184 x 184	250 x 250
Dimension (W X D X H) in mm	394 x 392 x 101	505 x 500 x 105
Cat Code	100MS05011000R	100MS20010600R

# Magnetic Hot Plate Stirrers

MHPS 350 / MHPS 550

The nano crystalline ceramic glass-top provides excellent resistance to thermal shock and corrosive liquids. The elevated design, protects the unit from spillages. Best in class capacity and speed of 20 lit and 2200 rpm. The unit comes with slip detection that can recover the stir bar in the event of it being lost outside the magnetic field.

The target temperature can be achieved in rapid or gradual or accurate modes depending upon the application. The unit can also be programmed to meet custom temperature and time conditions.

Accessories  
FREE







<b>MHPS 350</b>
Code : <b>100MHPS0103500</b>
<b>₹ 44308</b>

<b>MHPS 550</b>
Code : <b>100MHPS0105500</b>
<b>₹ 46398</b>

## Technical Information

Specification	MHPS 350	MHPS 550
Max capacity in lit	20	20
Max speed (rpm)	2200	2200
Temp range (from ambient)	350°C	550°C
Stirring positions	One	One
Set up plate	Ceramic	Ceramic
Protection Class	IP21	IP21
Dimension (W X D X H) in mm	220 x 330 x 115	220 x 330 x 115
Set up plate in mm	180 x 180	180 x 180
Display	digital	digital
Product code	100MHPS0103500	100MHPS0105500

# Shakers

## 7500S / PL Four / 3D-S

Shakers produce true linear or orbital motion using brushless dc motors.

Digital display and soft touch control panel interface for fatigue free convenience. Microprocessor control allows for custom programming of speed and time.

The platform shaker 7500S can handle a mass of 7.5 kg.

Platform  
Free





**7500S**

Code : **100S0000075000**



**PL Four**

Code : **100PL000400000**



**3D - S**

Code : **1003DS0000080R**

## Technical Information

Specification	7500S	PL Four	3D - S
Type of movement	Orbital / Linear	Orbital	Rocking / Tumbling 7°
Orbital diameter in mm	10	4	-
Speed range in rpm	50-500	100-1200	10-80
Motor type	BLDC	BLDC	BLDC
Display	digital	digital	digital
Run time	0-99 hrs and 0-60min	1-999 min and infinite	1-999 min and infinite
Dimension (W X D X H) in mm	350 x 408 x 105	343 x 195 x 88	307 x 267 (for plate)
Product code	100S0000075000	100PL000400000	1003DS0000080R

# Clinical Centrifuges

## DCF06VT / CCF4000VT

Centrifuges for clinical applications are designed to accommodate rotors and centrifuge tubes of varied sizes.

The CCF 4000VT is designed to accommodate both a swing out rotor for improved separation as well as a 16 position rotor for high throughput while still remaining compact.

The DCF06VT provides a modern but economical centrifuge for basic clinical separations.

Accessories  
**FREE**





**DCF06VT**

Code : **100DCF00600VT0**



**CCF4000VT**

Code : **100CCF00800VT0**

### Technical Information

Specification	DCF06VT	CCF4000VT
Rotor position	Fixed angle	Fixed and swing-out
Tube capacity in ml	5 / 7 / 9 / 15	10 / 15
Max rpm	6500	4000
Lid lock safety	Yes	Yes
Display	digital	digital
Imbalance detection	Yes	Yes
Dimension (W X D X H) in mm	260 x 244 x 205	415 x 355 x 173
Product code	100DCF00600VT0	100CCF00800VT0

# Micro Centrifuges

**MCF08VT / HMCF12VT**

LabQuest micro centrifuges are engineered for advanced aerodynamics to ensure low heat generation due to air friction and low noise operation.

Safety features include imbalance detection with auto cut-off. Electronic brake for auto stop on lid opening. Rotor and adaptors are supplied as standard accessories.

Accessories  
**FREE**





**MCF08VT**

Code : **100MCF00800VT0**



**HMCF12VT**

Code : **100HMCF1200VT0**

### Technical Information

Specification	MCF08VT	HMCF12VT
Rotor position	8	12
Tube capacity in ml	1.5 / 2.0 / 0.2 / 0.5	1.5 / 2.0 / 0.2 / 0.5
Max rpm	6000	15000
RCF	2000	15596
Display	digital	digital
Noise level	< 55db	< 60db
Imbalance detection	No	Yes
Dimension (W X D X H) in mm	162 x 157 x 116	260 x 244 x 205
Product code	100MCF00800VT0	100HMCF1200VT0

# Tube Disc Rotators

## SDR 16 / DDR 24

The SDR 16 is functional tube rotator which is robust and compact. The fixed speed of 30 rpm and the gentle circular motion generated is ideal for effective mixing in blood collection tubes.

The DDR 24 is microprocessor controlled with brush-less dc motor and digital display.

The auto power- on feature ensures continuity of the operation in the event of a power failure.

Accessories  
**FREE**







**SDR 16**

Code : **100CTR0160030R**



**DDR 24**

Code : **100DDR024VT80R**

## Technical Information

Specification	SDR 16	DDR 24
Tube Capacity	16x10ml or Blood tube	12x,50ml, 24x15ml, 44x2ml
Speed	Fixed	Variable
rpm	30	10 - 80
Time in min	Infinite	1-99 min & infinite
Motor	AC	BLDC
Protection Class	IP 21	IP 21
Pulse mode	NO	Yes
Dimension	278 x 183 x 252	383 x 325 x 325
Cat Code	100CTR0160030R	100DDR024VT80R

# Tube Rollers

**TR - 4 / TR - 6 / TR - 10**

Tube rollers are offered to meet the budgets and applications of all labs. Rollers can be easily mounted or removed without any tools.

Rollers can also be adjusted to accommodate tubes of different diameters.

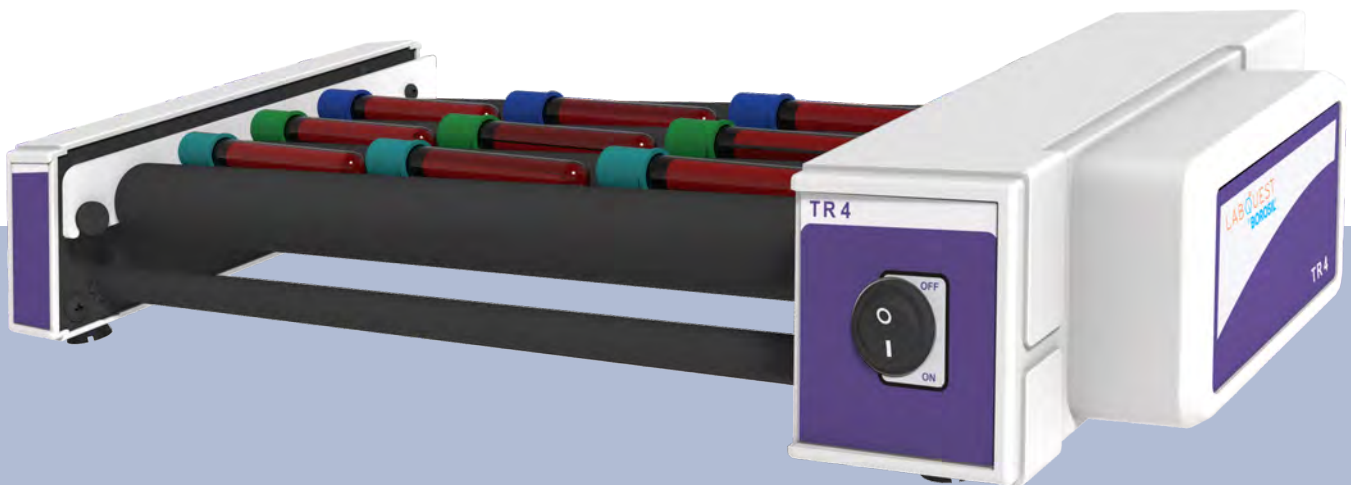

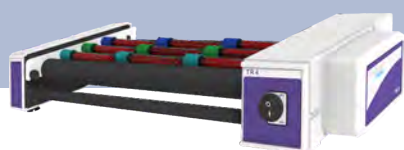

**TR - 4**  
Code : **100R0000415000**



**TR - 6**  
Code : **100R0000620000**

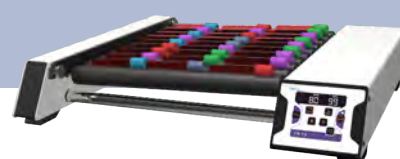

**TR - 10**  
Code : **100R0001020000**

## Technical Information

Specification	TR - 4	TR - 6	TR - 10
Number of tubes (in ml)	9 x 5	15 x 7	27 x 7
Motion	Rocking & Rolling	Rocking & Rolling	Rocking & Rolling
Motor	AC	BLDC	BLDC
Speed	fixed	variable	variable
rpm	30	10 to 80	10 to 80
Timer	-	Yes	Yes
Pulse mode	-	Yes	Yes
Protection Class	IP 21	IP 21	IP 21
Dimension (W X D X H) in mm	475 x 210 x 80	502 x 301 x 92.5	502 x 448 x 92.5
Product Code	100R0000415000	100R0000620000	100R0001020000

# Accessories

## Shaker 7.5Kg

Product Code	Description
100S00009UPB75 *	Universal platform with adjustable bars (Flask capacity 9 x 250ml, 6 x 500 ml)
100S02509BPP75	Base plate with 9 plastic clamps : 9 x 250 ml
100S05009BPP75	Base plate with 9 plastic clamps : 9 x 500 ml
100S01009BPS75	Base plate with 9 Stainless steel clamps : 9 x 100 ml
100S02509BPS75	Base plate with 9 Stainless steel clamps : 9 x 250 ml
100S05009BPS75	Base plate with 9 Stainless steel clamps : 9 x 500 ml
100S01001SSC00	Stainless steel Clamp for 100 ml flask
100S01501SSC00	Stainless steel Clamp for 150 ml flask
100S02501SSC00	Stainless steel Clamp for 250 ml flask
100S05001SSC00	Stainless steel Clamp for 500 ml flask
100S10001SSC00	Stainless steel Clamp for 1000 ml flask

## Vortex VMS/VMSP

Product Code	Description
100VMSP00UP000*	Universal Platform
100VMSP00MPF00*	Microplate foam
100VMSP00MTF00*	Microtube Foam
100VMSP01FH250*	Flask Holder 250ml

## Hot Plate Magnetic Stirrer MHPS 350/550

Product Code	Description
100MHPS01PT100*	PT 1000
100MHPS01PS000*	Probe Stand
100MHPS01PC000	Ceramic plate

**\*Supplied with Unit**

## Clinical Centrifuge CCF 4000 VT

Product Code	Description
100CCFA0610MLS*	Rotor for CCF 8 swing, 10ml x 6
100CCFA0815MLF	Rotor for CCF 8 fix, 15ml x 8
100CCFA1610MLF	Rotor for CCF 8 fix, 10ml x 16

## Multi Vortexer VMMA

Product Code	Description
100VMMA600700T*	Accessories for Multi vortex for 60 tube (7 ml)
100VMMA451500T*	Accessories for Multi vortex for 45 tube (15 ml)
100VMMA185000T*	Accessories for Multi vortex for 18 tube (50 ml)
100VMMA062500F*	Accessories for Multi vortex for 6 flask (250 ml)

## Digital disk tube rotator DDR 24

Product Code	Description
100DDRA1250MLT*	50 ml disc for DDR
100DDRA2415MLT*	15 ml disc for DDR
100DDRA4402MLT*	2 ml disc for DDR

C<sub>1</sub>

The High Precision Micropipette



For high precision and fatigue free micropipetting with a unique volume selection mechanism

- Silicone o-ring for optimal tip seal
- Robust design includes metal tip base
- Low operating thumb force

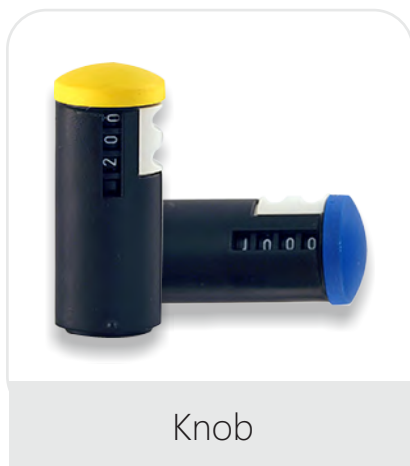



### C1 Single Channel Fixed Vol Pipette, Calibration & Accuracy As Per ISO 8655

Product Code	Volume Range (µl)	Inaccuracy (%)	Imprecision
LHC17111001	1	2.5	1.8
LHC17111002	2	2.5	1.8
LHC17111005	5	1.2	0.8
LHC17111006	10	1	0.5
LHC17111008	20	1	0.3
LHC17111009	25	0.8	0.35
LHC17111010	30	1.16	0.4
LHC17111012	50	1	0.3
LHC17111016	100	0.7	0.2
LHC17111020	200	0.6	0.2
LHC17111024	500	0.8	0.15
LHC17111029	1000	0.8	0.2
LHC17111033	5000	0.6	0.15

### C1 Single Channel Variable Vol Pipette, , Calibration & Accuracy As Per ISO 8655

Product Code	Volume Range (µl)	Inaccuracy (%)	Imprecision
LHC17112002	0.2-2	12.00/2.0	06.00/1.00
LHC17112005	0.5-10	2.50/1.0	01.80/0.50
LHC17112008	2-20	5.00/1.00	1.50/0.30
LHC17112016	5-50	2.00/1.00	1.20/0.30
LHC17112020	10-100	2.50/0.70	1.00/0.20
LHC17112024	20-200	2.50/0.60	0.70/0.20
LHC17112029	100-1000	2.00/0.80	0.60/0.20
LHC17112033	1000-5000	1.20/0.60	0.30/0.15

Convert fixed volume pipette to a variable volume pipette

C1 Micropipettes come with detachable pre calibrated volume knobs. Cut costs while increasing the accuracy of your experiments.

Product	Description	Qty / Pk
LHC17111S00*	C1 Fixed Vol Knob	1
LHC17112S00*	C1 Variable Vol Knob	1



#### C1 Pipette 8 Channel, Calibration & Accuracy As Per ISO 8655

Product Code	Volume Range (µl)	Inaccuracy (%)	Imprecision
LHC17113001	0.5-10	5.00/2.00	3.60/1.00
LHC17113002	2-20	5.00/2.00	3.60/1.00
LHC17113009	5-50	3.20/1.40	1.60/0.60
LHC17113016	10-100	2.50/1.30	1.20/0.50
LHC17113020	20-200	1.80/1.20	0.80/0.40
LHC17113022	30-300	1.66/1.40	0.60/0.30

#### C1 Pipette 12 Channel, , Calibration & Accuracy As Per ISO 8655

Product Code	Volume Range (µl)	Inaccuracy (%)	Imprecision
LHC17114001	0.5-10	5.00/2.00	3.60/1.00
LHC17114002	2-20	5.00/2.00	3.60/1.00
LHC17114009	5-50	3.20/1.40	1.60/0.60
LHC17114016	10-100	2.50/1.30	1.20/0.50
LHC17114020	20-200	1.80/1.20	0.80/0.40
LHC17114022	30-300	1.66/1.40	0.60/0.30



LABQUEST  
BY BOROSIL®

C<sub>3</sub>

The eco micropipette range



Fully  
Autoclavable

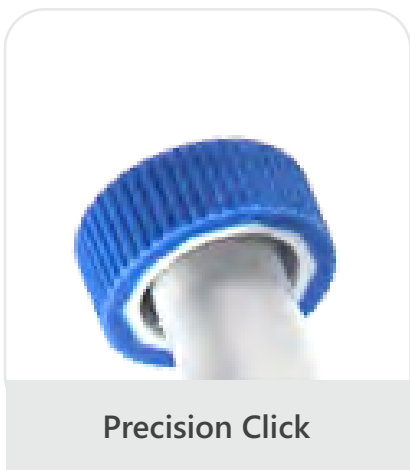

Precision Click



Easy to read dial



Soft Plunger Light weight



**C3 Single Channel Fixed Vol Pipette , Calibration & Accuracy  
As Per ISO 8655**

Product Code	Volume Range (µl)	Inaccuracy (%)	Imprecision
LHC37111001	1	2.5	1.8
LHC37111002	2	2.5	1.2
LHC37111005	5	1.2	0.8
LHC37111006	10	1	0.5
LHC37111008	20	1	0.3
LHC37111009	25	0.8	0.35
LHC37111010	30	1.16	0.4
LHC37111012	50	1	0.3
LHC37111016	100	0.7	0.2
LHC37111020	200	0.6	0.2
LHC37111024	500	0.8	0.15
LHC37111029	1000	0.8	0.2
LHC37111033	5000	0.6	0.15
LHC37111038	10000	0.6	0.15

**C3 Single Channel Variable Vol Pipette, Calibration & Accuracy  
As Per ISO 8655**

Product Code	Volume Range (µl)	Inaccuracy (%)	Imprecision
LHC37112002	0.2-2	12.00/2.00	6.00/1.00
LHC37112005	0.5-10	2.50/1.00	1.80/0.50
LHC37112008	2-20	5.00/1.00	1.50/0.30
LHC37112016	5-50	2.00/1.00	1.20/0.30
LHC37112020	10-100	2.50/0.70	1.00/0.20
LHC37112024	20-200	2.50/0.60	0.70/0.20
LHC37112029	100-1000	2.00/0.80	0.60/0.20
LHC37112033	500-5000	1.20/0.60	0.30/0.15
LHC37112038	1000-10000	3.00/0.60	0.60/0.15

## CE

### Electronic Micropipette



High Resolution  
Digital interface



USB Charging

**3**  
Point  
Calibration  
System



## CE Electronic Pipette, Calibration & Accuracy As Per ISO 8655

Product	Volume Code (µl)	Test Volume Range	Inaccuracy (µl)	Imprecision (%)
LHC17022042	0.5-10	1	2.5	1.8
		5	2	1
		10	1	0.6
LHC17022012	5 - 100	10	3	1
		50	1	0.5
		100	0.8	0.2
LHC17022008	10 - 200	20	2.5	0.7
		100	0.7	0.3
		200	0.6	0.2
LHC17022024	50 - 1000	100	3	0.6
		500	1	0.4
		1000	0.6	0.2
LHC17022016	250 - 5000	500	2.4	0.6
		2500	1.7	0.25
		5000	0.6	0.15



CE electronic pipette 8 Channel,  
Calibration and Accuracy As per  
ISO 8655

Product Code	Volume Range (µl)
LHC17023001	0.5-10
LHC17023002	2-20
LHC17023016	5-100
LHC17023020	10-200
LHC17023022	15-300



CE electronic pipette 12 Channel,  
Calibration and Accuracy As per  
ISO 8655

Product Code	Volume Range (µl)
LHC17024001	0.5-10
LHC17024002	2-20
LHC17024016	5-100
LHC17024020	10-200
LHC17024022	15-300

Fast Pipette  
Pipette Controller

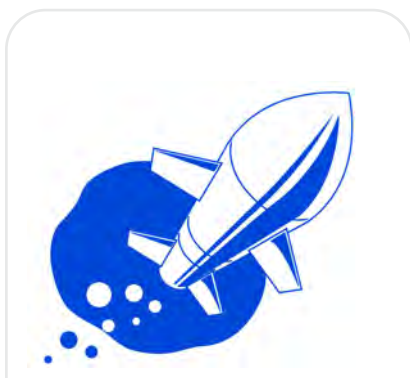

High Speed 25 ml in 4 sec



Safety Valve Hydrophobic Membrane Filter



Desktop & Wall Mount Stand

C1 Pipette filling device

Product Code	Description
LHC17005011	Borosil C1 Pipette filling device

**2012 - Bottle Top Dispensers Pinnacle Model - with Re-circulation Valve, Calibration And Accuracy As Per ISO 8655**

Product	Vol. Range (ml)	Increment (ml)	Accuracy		CV	
			± %	± ml	± %	± ml
LH002012002	0.25 - 2.5	0.05	0.6	0.015	0.2	0.005
LH002012005	0.5 - 5.0	0.10	0.5	0.025	0.1	0.005
LH002012016	1.0 - 10.0	0.20	0.5	0.050	0.1	0.010
LH002012020	2.5 - 30.0	0.50	0.5	0.150	0.1	0.030
LH002012040	5.0 - 60.0	1.00	0.5	0.300	0.1	0.060
LH002012100	10.0 - 100.0	2.00	0.5	0.500	0.1	0.100



**2011 - Bottle Top Dispensers Research Model - Fully Autoclavable, Calibration And Accuracy As Per ISO 8655**

Product	Vol. Range (ml)	Increment (ml)	Accuracy		CV	
			± %	± ml	± %	± ml
LH002011002	0.25 - 2.5	0.05	0.6	0.012	0.2	0.004
LH002011005	0.5 - 5.0	0.10	0.6	0.030	0.2	0.010
LH002011016	1.0 - 10.0	0.20	0.6	0.060	0.2	0.020
LH002011020	2.5 - 30.0	0.50	0.6	0.180	0.2	0.060
LH002011040	5.0 - 60.0	1.00	0.6	0.360	0.2	0.120
LH002011100	10.0 - 100.0	2.00	0.5	0.500	0.1	0.100

Dispensers come with 20mm, 32mm, 36mm, 40mm & 45mm bottle neck adapters.



**2013 - Bottle Top Dispenser Ultimus - With Dual Valve Technology Calibration and Accuracy As Per ISO 8655**

Product	Capacity (ml)
LH002013002	0.25 - 2.5
LH002013005	0.5 - 5.0
LH002013016	1.0 - 10.0
LH002013020	2.5 - 30.0
LH002013040	5.0 - 60.0
LH002013100	10.0 - 100.0

Dispensers come with 28mm, 30mm, 32mm, 36mm, 40mm & 45mm bottle neck adapters.



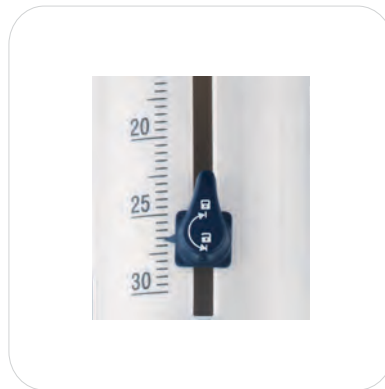

## 2011 - Bottle Top Dispenser Spares

Product Code	Description
LH002011S01	Set of 5 Adapters 28 / 32 / 36 / 40 / 45 mm - BTDR - ADPT
LH002011S02	Telescopic Tube Common For All Sizes- BTDR - IT
LH002011S03	Volume Adjustment Knob For 2.5 / 5 / 10 ml Dispenser - BTDR - VAK - I
LH002011S04	Volume Adjustment Knob For 30 / 60 / 100 ml Dispenser - BTDR - VAK - II
LH002011S05	Delivery Nozzle With PTFE Screw Adapter And FEP Tubing For 2.5 / 5 / 10 ml Dispenser BTDR - DN - I
LH002011S06	Delivery Nozzle With PTFE Screw Adapter And FEP Tubing For 30 / 60 / 100 ml Dispenser - BTDR - DN - II
LH002011S07	Delivery Tube Cover With Nozzel Cap Common For All Sizes - BTDR - DTC

## 2012 - Bottle Top Dispenser Spares

Product Code	Description
LH002012S01	Set of 5 Adapters 28 / 32 / 36 / 40 / 45 mm - BTDR - ADPT
LH002012S02	Telescopic Tube Common For All Sizes- BTDR - IT
LH002012S03	Volume Adjustment Knob For 2.5 / 5 / 10 ml Dispenser - BTDR - VAK - I
LH002012S04	Volume Adjustment Knob For 30 / 60 / 100 ml Dispenser - BTDR - VAK - II
LH002012S05	Delivery Nozzle With PTFE Screw Adapter And FEP Tubing For 2.5 / 5 / 10 ml Dispenser BTDR - DN - I
LH002012S06	Delivery Nozzle With PTFE Screw Adapter And FEP Tubing For 30 / 60 / 100 ml Dispenser - BTDR - DN - II
LH002012S07	Delivery Tube Cover With Nozzel Cap Common For All Sizes - BTDR - DTC

# Premium Pipette Tips

All **BOROSIL** tips are.....

- Certified DNase, RNase and Pyrogen Free
- Free of PCR inhibitors, lubricants and heavy metals
- Produced from special diamond polish mould using medical grade virgin polypropylene which provides very high transparency
- With graduations for visual control of liquid transfer
- Available in both standard as well as low retention
- With no secondary treatment and with no silicone additives for low retention
- With special PE filters for prevention of aerosols and contamination
- Specifically configured to fit major Pipette Brands available worldwide

**BOROSIL's** pipette tips range includes

- Sterile
- Non sterile
- Low retention
- Filter

in capacities of 10µl, 10µl Long, 20µl, 50µl, 100µl, 200µl and 1000µl and are available in **Bulk, Rack and Reload system**

## FILTER TIPS

**BOROSIL** filter tips are manufactured using specifically developed Polyethylene filters to block aerosols from entering into the pipette.

This helps in prevention of cross contamination.

Ideal for use in applications like sequencing, DNA amplification, Tissue culture, RT-PCR and other critical protocols.

## LOW RETENTION TIPS

**BOROSIL** low retention tips are manufactured from a specific resin in combination with high quality diamond finish moulds to give super hydrophobic internal surface. This results in tips having minimum retention with maximum accuracy.

Further since no silicone treatment is given, there is absolutely no leaching effect.





- Easy tearing
- Self Standing PET bag
- Double sealed bag to prevent contamination



**10 µl Universal Graduated Tips**

1000 Tips / Pack (10 Packs / Case)

Catalogue No.	Sterile	Low Retention	Filter
BGT-10B	-	-	-
BGT-10FB	-	-	●



**10 µl Long Universal Graduated Tips**

1000 Tips / Pack (10 Packs / Case)

Catalogue No.	Sterile	Low Retention	Filter
BGT-10XLB	-	-	-
BGT-10XLFB	-	-	●



**20 µl Universal Graduated Tips  
(With Filter only)**

1000 Tips / Pack (5 Packs / Case)

Catalogue No.	Sterile	Low Retention	Filter
BGT-20FB	-	-	●



**50 µl Universal Graduated Tips  
(With Filter only)**

1000 Tips / Pack (5 Packs / Case)

Catalogue No.	Sterile	Low Retention	Filter
BGT-50FB	-	-	●



B = Bulk / C = Colour / F = Filter / L - Low retention / R = Rack / S - Sterile / Z = Reload

## BULK



### 100 µl Universal Graduated Tips (With Filter only)

1000 Tips / Pack ( 5 Packs / Case)

Catalogue No.	Sterile	Low Retention	Filter
BGT-100FB	-	-	●



### 200 µl Universal Graduated Tips

1000 Tips / Pack (10 Packs / Case)

Catalogue No.	Sterile	Low Retention	Filter
BGT-200B	-	-	-
BGT-200BC*	-	-	-
BGT-200FB	-	-	●

\* C indicates YELLOW Colour



### 1000 µl Universal Graduated Tips

1000 Tips / Pack (10 Packs / Case)

Catalogue No.	Sterile	Low Retention	Filter
BGT-1000B	-	-	-
BGT-1000BC*	-	-	-
BGT-1000FB	-	-	●

\* C indicates BLUE Colour

B = Bulk / C = Colour / F = Filter / L - Low retention / R = Rack / S - Sterile / Z = Reload

- Fully autoclavable and stackable
- Hinge rack allows single hand operation

## RACK



### 10 µl Universal Graduated Tips

96 Tips x 10 Racks / Pack

Catalogue No.	Sterile	Low Retention	Filter
BGT-10R	-	-	-
BGT-10SR	●	-	-
BGT-10FR	-	-	●
BGT-10SLR	●	●	-
BGT-10SFR	●	-	●
BGT-10SLFR	●	●	●



### 10 µl Long Universal Graduated Tips

96 Tips x 10 Racks / Pack

Catalogue No.	Sterile	Low Retention	Filter
BGT-10XLSR	●	-	-
BGT-10XLSLR	●	●	-
BGT-10XLSFR	●	-	●
BGT-10XLSLFR	●	●	●



### 20 µl Universal Graduated Tips (With Filter only)

96 Tips x 10 Racks / Pack

Catalogue No.	Sterile	Low Retention	Filter
BGT-10XLSR	-	-	●
BGT-10XLSLR	●	-	●
BGT-10XLSFR	●	●	●



### 50 µl Universal Graduated Tips (With Filter only)

96 Tips x 10 Racks / Pack

Catalogue No.	Sterile	Low Retention	Filter
BGT-50FR	-	-	●
BGT-50SFR	●	-	●
BGT-10XLSFR	●	●	●



B = Bulk / C = Colour / F = Filter / L - Low retention / R = Rack / S - Sterile / Z = Reload

# RACK

## 100 µl Universal Graduated Tips (With Filter only)

96 Tips x 10 Racks / Pack



Catalogue No.	Sterile	Low Retention	Filter
BGT-100FR	-	-	●
BGT-100SFR	●	-	●
BGT-100SLFR	●	●	●

## 200 µl Universal Graduated Tips

96 Tips x 10 Racks / Pack



Catalogue No.	Sterile	Retention	Filter
BGT-200R	-	-	-
BGT-200SR	●	-	-
BGT-200FR	-	-	●
BGT-200SLR	●	●	-
BGT-200SFR	●	-	●
BGT-200SLFR	●	●	●

\* C indicates YELLOW Colour

## 1000 µl Universal Graduated Tips

96 Tips x 6 Racks / Pack



Catalogue No.	Sterile	Retention	Filter
BGT-1000R	-	-	-
BGT-1000SR	●	-	-
BGT-1000FR	-	-	●
BGT-1000SLR	●	●	-
BGT-1000SFR	●	-	●
BGT-1000SLFR	●	●	●

\* C indicates BLUE Colour

B = Bulk / C = Colour / F = Filter / L - Low retention / R = Rack / S - Sterile / Z = Reload

## Micro Centrifuge Tubes

Certified RNase, DNase, DNA & Pyrogen Free | Centrifuge upto 20000 RCF  
Temperature range: -80°C to 121 °C | FDA approved resins | Universal rotor compatibility.

Product Code	Description	Pack Size
BGPMCT015C	1.5 ml Micro Centrifuge Tubes With Cap	500 x 2 (1000)



- Easy to operate
- Require less storage space
- Minimizes wastage and reduces carbon footprint

## RELOADING STACK

### 10 µl Universal Graduated Tips

96 Tips x 10 Plates / Pack (10 Packs / Case)

Catalogue No.	Sterile	Low Retention	Filter
BGT-10SZ	●	-	-
BGT-10SLZ	●	●	-

### 200 µl Universal Graduated Tips

96 Tips x 10 Plates / Pack (10 Packs / Case)

Catalogue No.	Sterile	Low Retention	Filter
BGT-200SZ	●	-	-
BGT-200SLZ	●	●	-

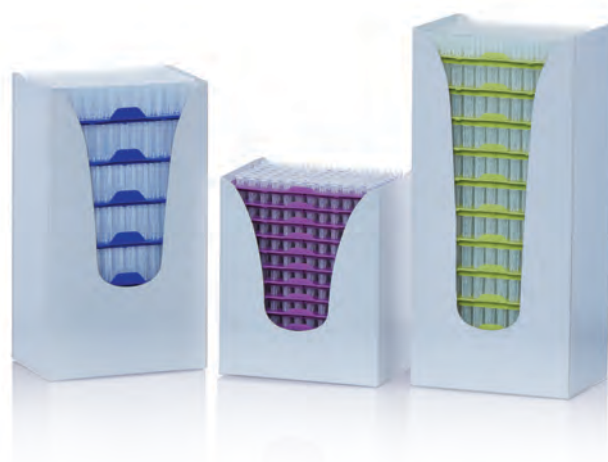

### 1000 µl Universal Graduated Tips

96 Tips x 10 Plates / Pack (10 Packs / Case)

Catalogue No.	Sterile	Low Retention	Filter
BGT-1000SZ	●	-	-
BGT-1000SLZ	●	●	-

### Empty Tip Boxes

Pack (5 Packs / Case)

Catalogue No.	Rack / Pack
BGT-10ETR	10
BGT-200ETR	10
BGT-1000ETR	6

B = Bulk / C = Colour / F = Filter / L - Low retention / R = Rack / S - Sterile / Z = Reload

### EMPTY TIP BOXES

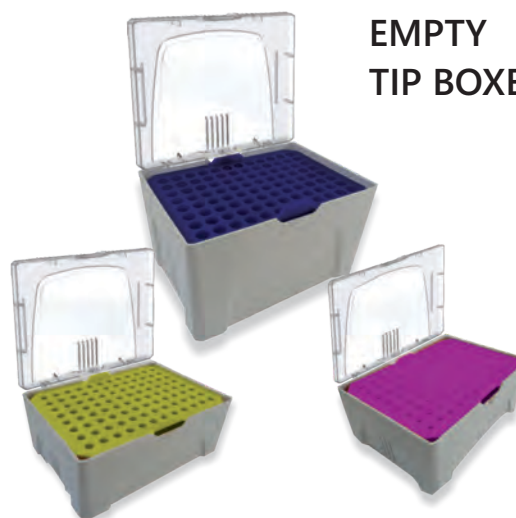

# BOROSIL®

## CAUTION NOTICE

We, **Borosil Glass Works Ltd.**, a company registered under the Companies Act, 1956 and having its registered office at Khanna Construction House, 44, Dr. R. G. Thadani Marg, Worli, Mumbai - 400 018, are the registered proprietor's of the Trademark **BOROSIL®**

The said, trademark **BOROSIL®** has been used by us in market, sell and export a wide variety of glassware products since more than 5(five) decades throughout India as well as several countries across the globe.

The Trademark **BOROSIL®** has acquired a very high reputation and goodwill by virtue of long, extensive and continuous use. The said trademark is associated and identified exclusively with the goods manufactured, marketed and sold by **Borosil Glass Works Ltd.**

It has, from time to time come to our notice that some persons occasionally try to sell spurious goods by copying the **BOROSIL®** trademark and/or 'Borosil Logo' 

The trade and public are cautioned that only products manufactured, marketed and sold by **Borosil Glass Works Ltd.**, are permitted to carry the trademark **BOROSIL®** or 'Borosil Logo' 

Those who are deceiving the public by copying the Trademark **BOROSIL®** or the 'Borosil Logo'  or using it wrongly on products not made, marketed and/ or sold by Borosil Glass Works Ltd. are hereby warned that **Borosil Glass Works Ltd.**, will adopt all legal recourse available to it, which may be Civil or Criminal in nature and may include police raids, to prevent such unauthorized use without giving further notice.

The Trade and Public are cautioned that they should always request for a bill on purchase of their products, as spurious goods are harmful and have dangerous and adverse effects to the life of the user as well as the nation.

We request you to bring to our attention any instances of such nefarious activities, which you may come across, we shall maintain the secrecy of you identity.

Correspondence in this connection may please be made at registered office address of the Company.





# BOROSIL®

CIN: L99999MH1962PLC012538

**Registered Office :** Khanna Construction House, 44, Dr. R.G. Thadani Marg, Worli, Mumbai - 400 018

**Corporate Office :** 1101, Crescenzo, G-Block, Opp. MCA Club, Bandra Kurla Complex, Bandra (E), Mumbai - 400 051, India

**Tel :**  
022 6740 6300

**Fax :**  
022 6740 6514

**Email :**  
borosil@borosil.com

**Website :**  
www.borosil.com